

NOTE: BLOCK MUST BE CLEAN AND FREE FROM DIRT AND OTHER FOREIGN MATERIAL BEFORE INSTALLATION OF STONE

PLAN VIEW

QSY-01.0

SCALE: 3" = 1'-0"

MANUFACTURED STONE
ON C.M.U. WALL

QUALITY STONE VENEER

PHONE: 1-800-795-3229
FAX: 717-806-0961
WWW.QUALITYSTONEVENEER.COM



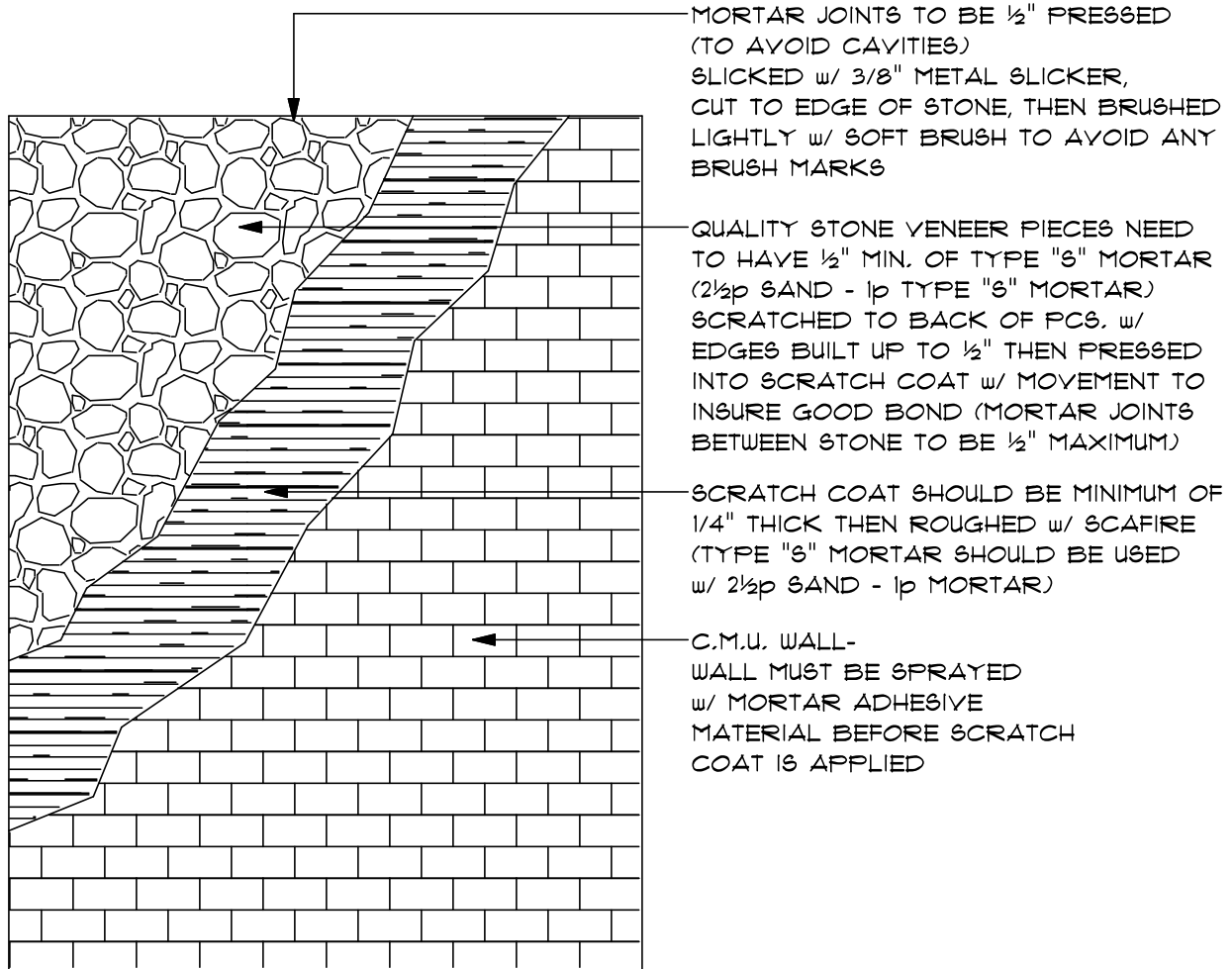

MORTAR JOINTS TO BE 1/2" PRESSED (TO AVOID CAVITIES) SLICKED w/ 3/8" METAL SLICKER, CUT TO EDGE OF STONE, THEN BRUSHED LIGHTLY w/ SOFT BRUSH TO AVOID ANY BRUSH MARKS

QUALITY STONE VENEER PIECES NEED TO HAVE 1/2" MIN. OF TYPE "S" MORTAR (2 1/2p SAND - 1p TYPE "S" MORTAR) SCRATCHED TO BACK OF PCS. w/ EDGES BUILT UP TO 1/2" THEN PRESSED INTO SCRATCH COAT w/ MOVEMENT TO INSURE GOOD BOND (MORTAR JOINTS BETWEEN STONE TO BE 1/2" MAXIMUM)

SCRATCH COAT SHOULD BE MINIMUM OF 1/4" THICK THEN ROUGHED w/ SCAFFIRE (TYPE "S" MORTAR SHOULD BE USED w/ 2 1/2p SAND - 1p MORTAR)

C.M.U. WALL- WALL MUST BE SPRAYED w/ MORTAR ADHESIVE MATERIAL BEFORE SCRATCH COAT IS APPLIED

ELEVATION VIEW

QSV-02.0

NO SCALE

MANUFACTURED STONE
ON C.M.U. WALL

QUALITY STONE VENEER

PHONE: 1-800-795-3229
FAX: 717-806-0961
WWW.QUALITYSTONEVENEER.COM



1/01

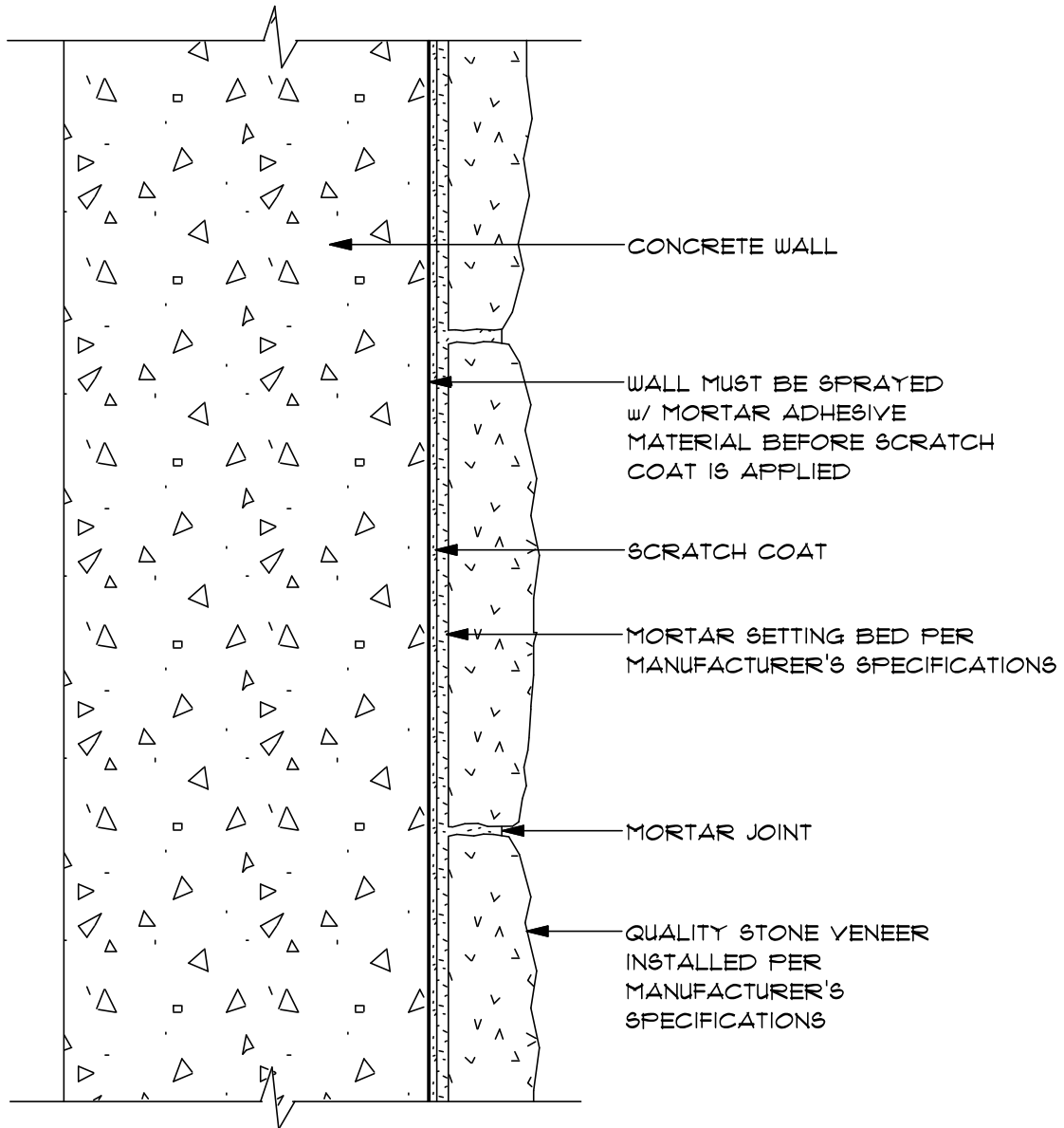

NOTE: CONCRETE MUST BE CLEAN
AND FREE FROM DIRT AND
OTHER FOREIGN MATERIAL
BEFORE INSTALLATION OF STONE

PLAN VIEW

QSV-03.0

SCALE: 3" = 1'-0"

MANUFACTURED STONE
ON CONCRETE WALL

QUALITY STONE VENEER

PHONE: 1-800-795-3229
FAX: 717-806-0961
WWW.QUALITYSTONEVENEER.COM



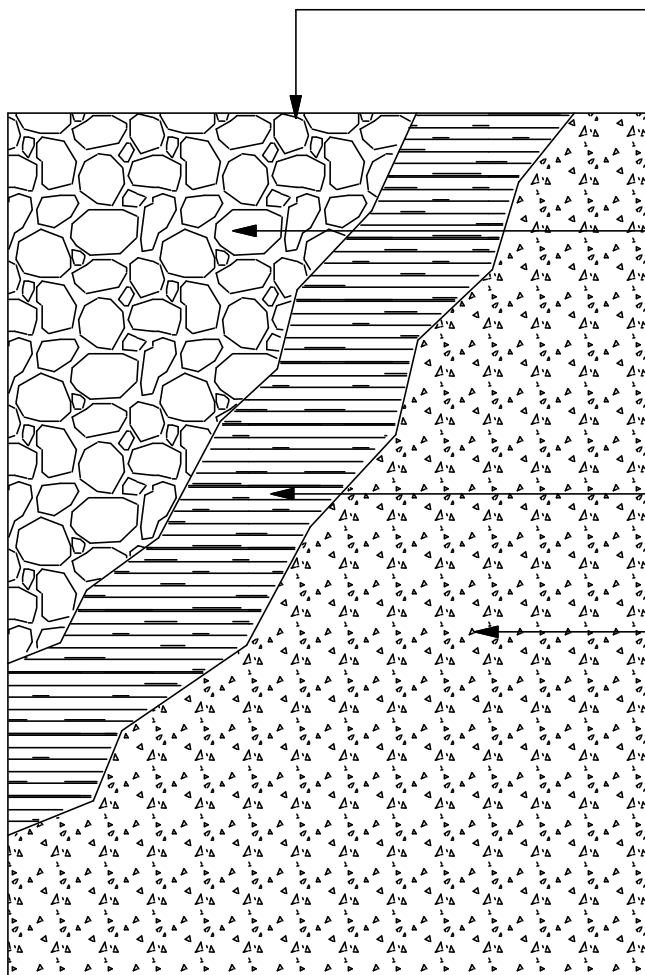

MORTAR JOINTS TO BE 1/2" PRESSED (TO AVOID CAVITIES)
SLICKED w/ 3/8" METAL SLICKER, CUT TO EDGE OF STONE, THEN BRUSHED LIGHTLY w/ SOFT BRUSH TO AVOID ANY BRUSH MARKS

QUALITY STONE VENEER PIECES NEED TO HAVE 1/2" MIN. OF TYPE "S" MORTAR (2 1/2p SAND - 1p TYPE "S" MORTAR) SCRATCHED TO BACK OF PCS. w/ EDGES BUILT UP TO 1/2" THEN PRESSED INTO SCRATCH COAT w/ MOVEMENT TO INSURE GOOD BOND (MORTAR JOINTS BETWEEN STONE TO BE 1/2" MAXIMUM)

SCRATCH COAT SHOULD BE MINIMUM OF 1/4" THICK THEN ROUGHED w/ SCAFFIRE (TYPE "S" MORTAR SHOULD BE USED w/ 2 1/2p SAND - 1p MORTAR)

CONCRETE WALL - WALL MUST BE SPRAYED w/ MORTAR ADHESIVE MATERIAL BEFORE SCRATCH COAT IS APPLIED

ELEVATION VIEW

1/01

QSV-04.0

NO SCALE

MANUFACTURED STONE
ON CONCRETE WALL

QUALITY STONE VENEER

PHONE: 1-800-795-3229
FAX: 717-806-0961
WWW.QUALITYSTONEVENEER.COM



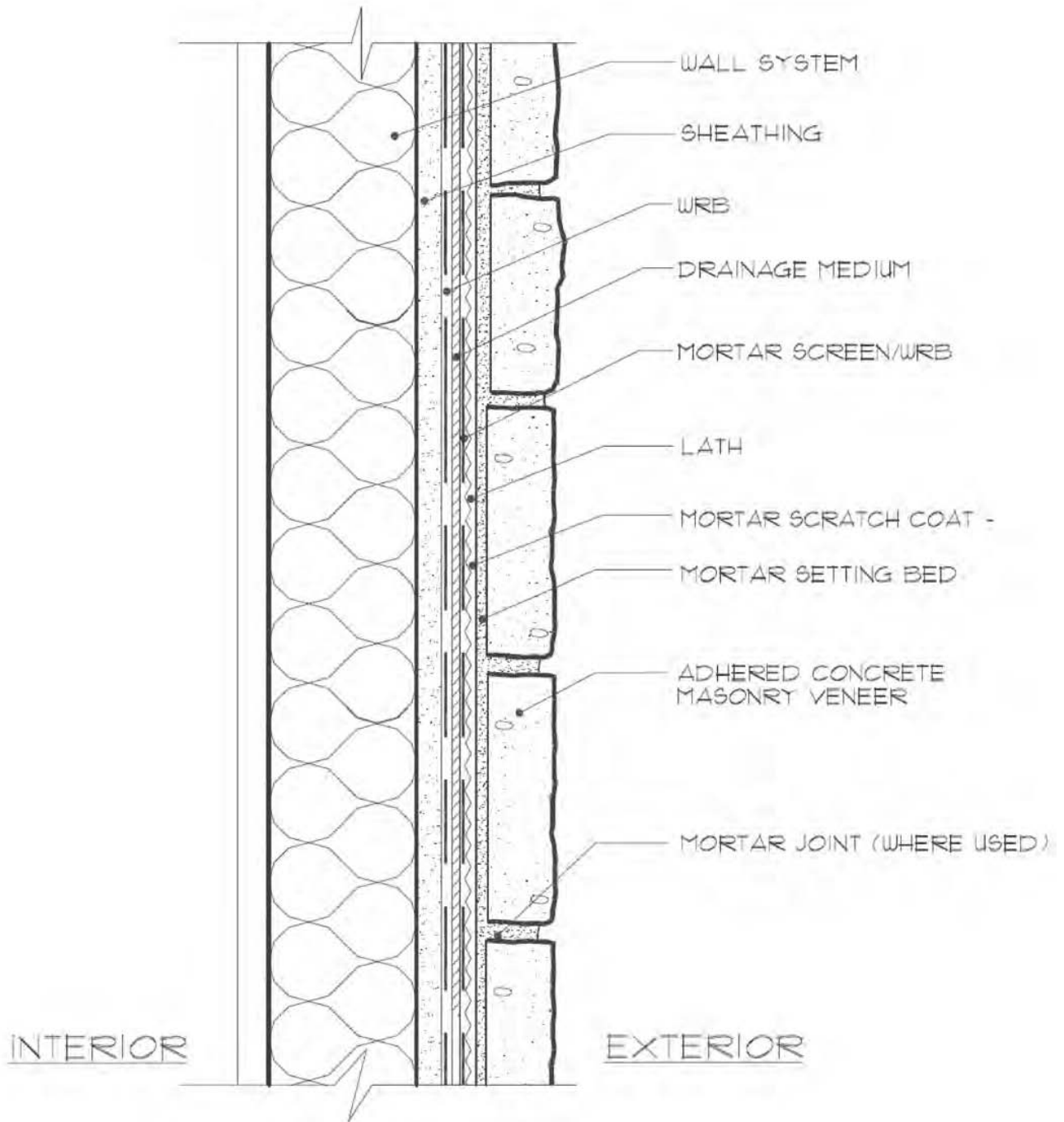

PLAN VIEW

9/01

QSV-05.0

SCALE: 3" = 1'-0"

MANUFACTURED STONE
ON STUD WALL

QUALITY STONE VENEER

PHONE: 1-800-795-3229
FAX: 717-806-0961
WWW.QUALITYSTONEVENEER.COM



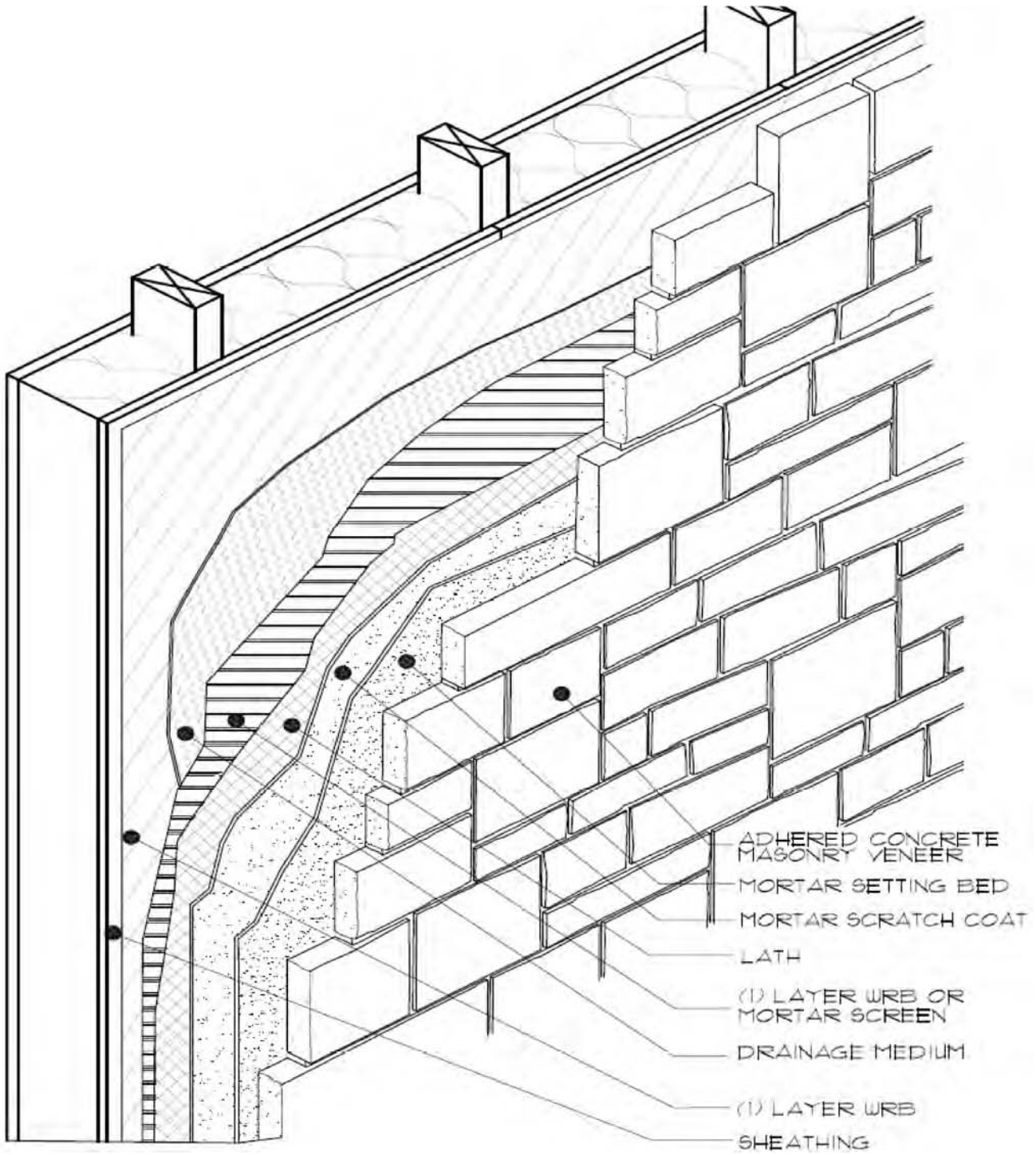

ELEVATION VIEW

9/01

QSV-06.0

NO SCALE

MANUFACTURED STONE
ON STUD WALL

QUALITY STONE VENEER

PHONE: 1-800-795-3229
FAX: 717-806-0961
WWW.QUALITYSTONEVENEER.COM



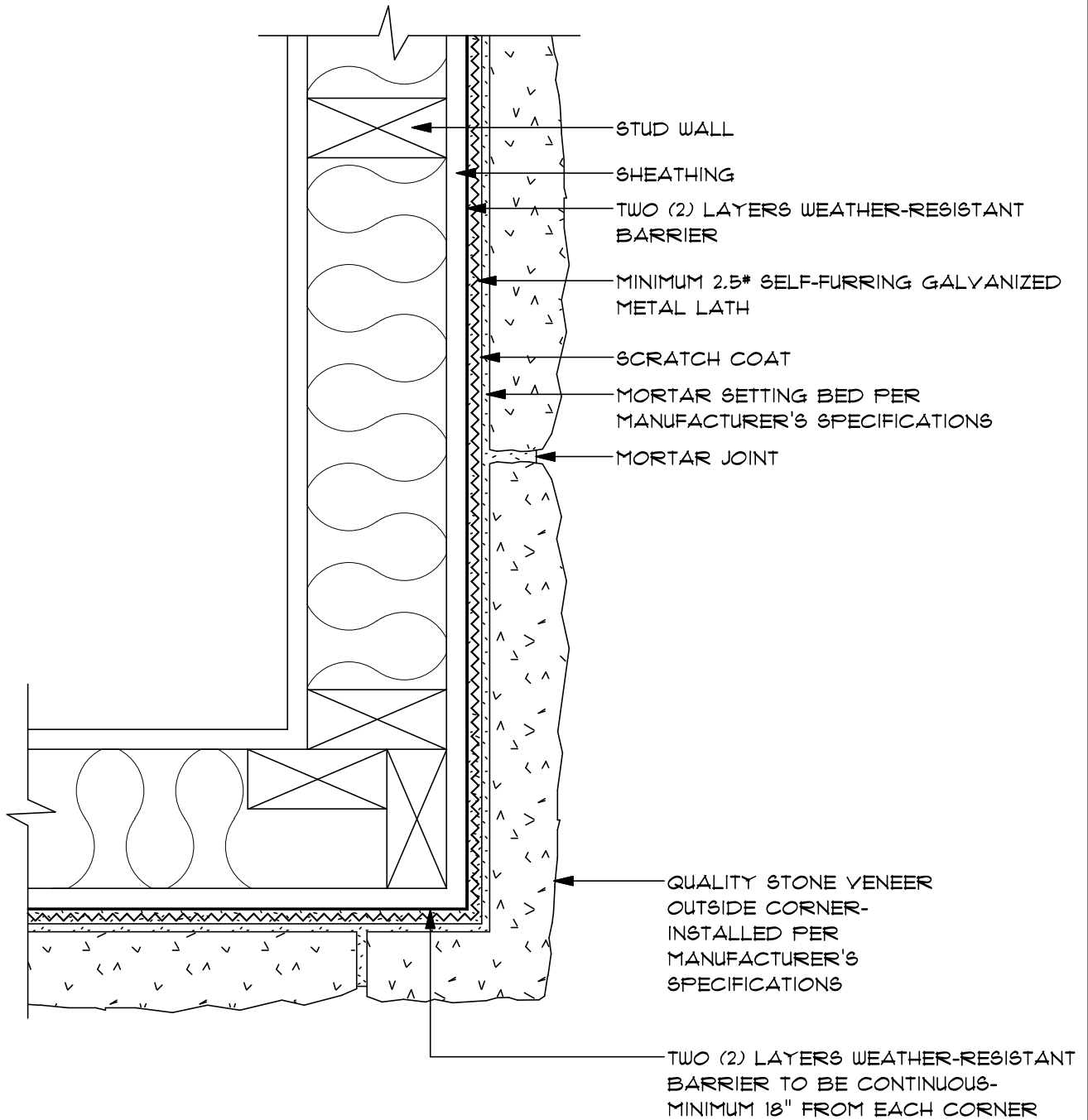

PLAN VIEW

9/01

QSY-07.0

SCALE: 3" = 1'-0"

**OUTSIDE CORNER INSTALLATION
DETAIL AT MANUF. STONE**

QUALITY STONE VENEER

PHONE: 1-800-795-3229
FAX: 717-806-0961
WWW.QUALITYSTONEVENEER.COM



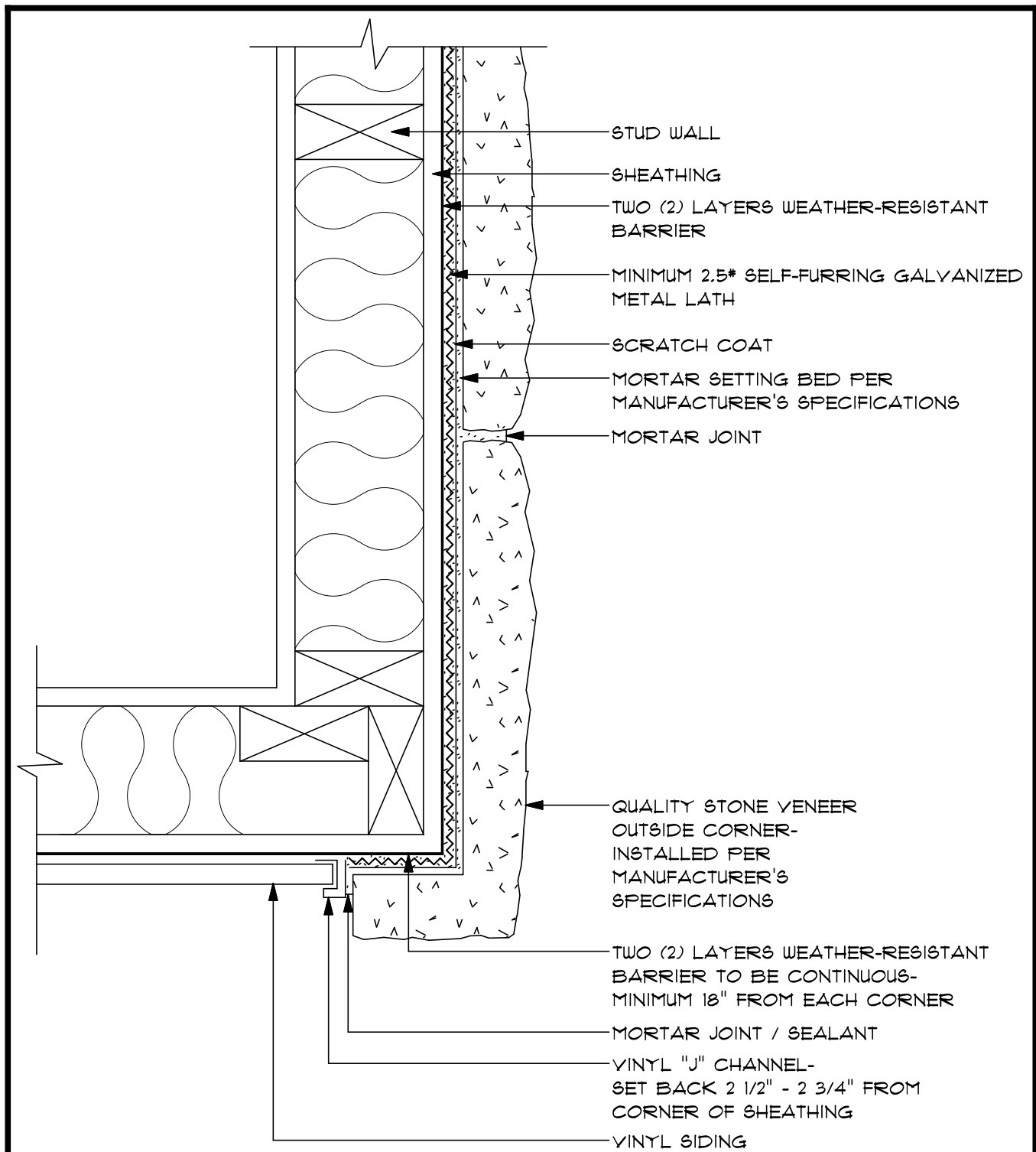

PLAN VIEW

9/01

QSV-08.0

SCALE: 3" = 1'-0"

**OUTSIDE CORNER TRANSITION
AT MANUFACTURED STONE**

FOR STUCCO, MASONITE,
WOOD & VINYL SIDING TRANSITION

QUALITY STONE VENEER

PHONE: 1-800-795-3229
FAX: 717-806-0961
WWW.QUALITYSTONEVENEER.COM

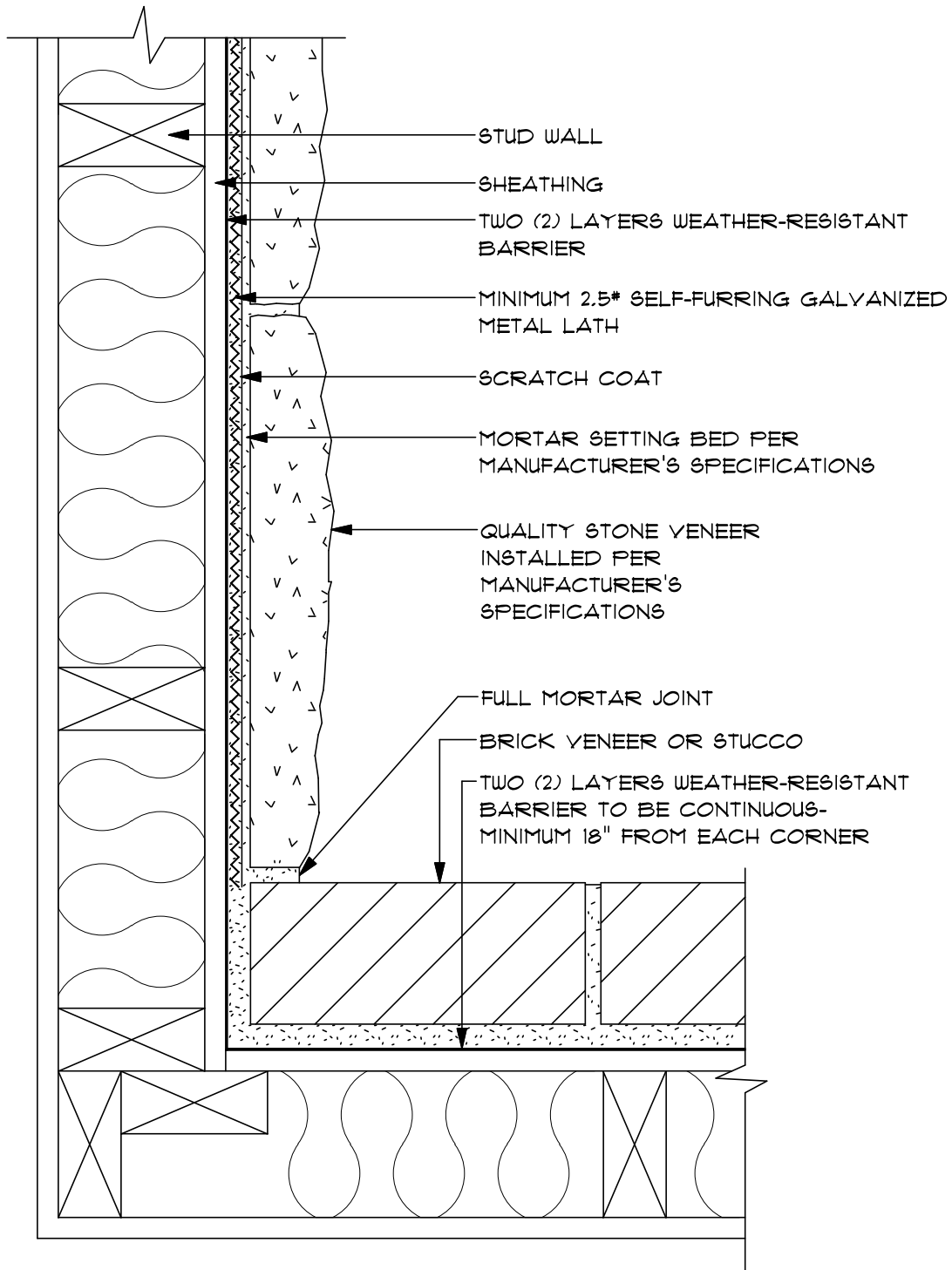

PLAN VIEW

9/01

QSV-09.0

SCALE: 3" = 1'-0"

INSIDE CORNER TRANSITION
AT MANUFACTURED STONE

FOR BRICK OR STUCCO TRANSITION

QUALITY STONE VENEER

PHONE: 1-800-795-3229

FAX: 717-806-0961

WWW.QUALITYSTONEVENEER.COM



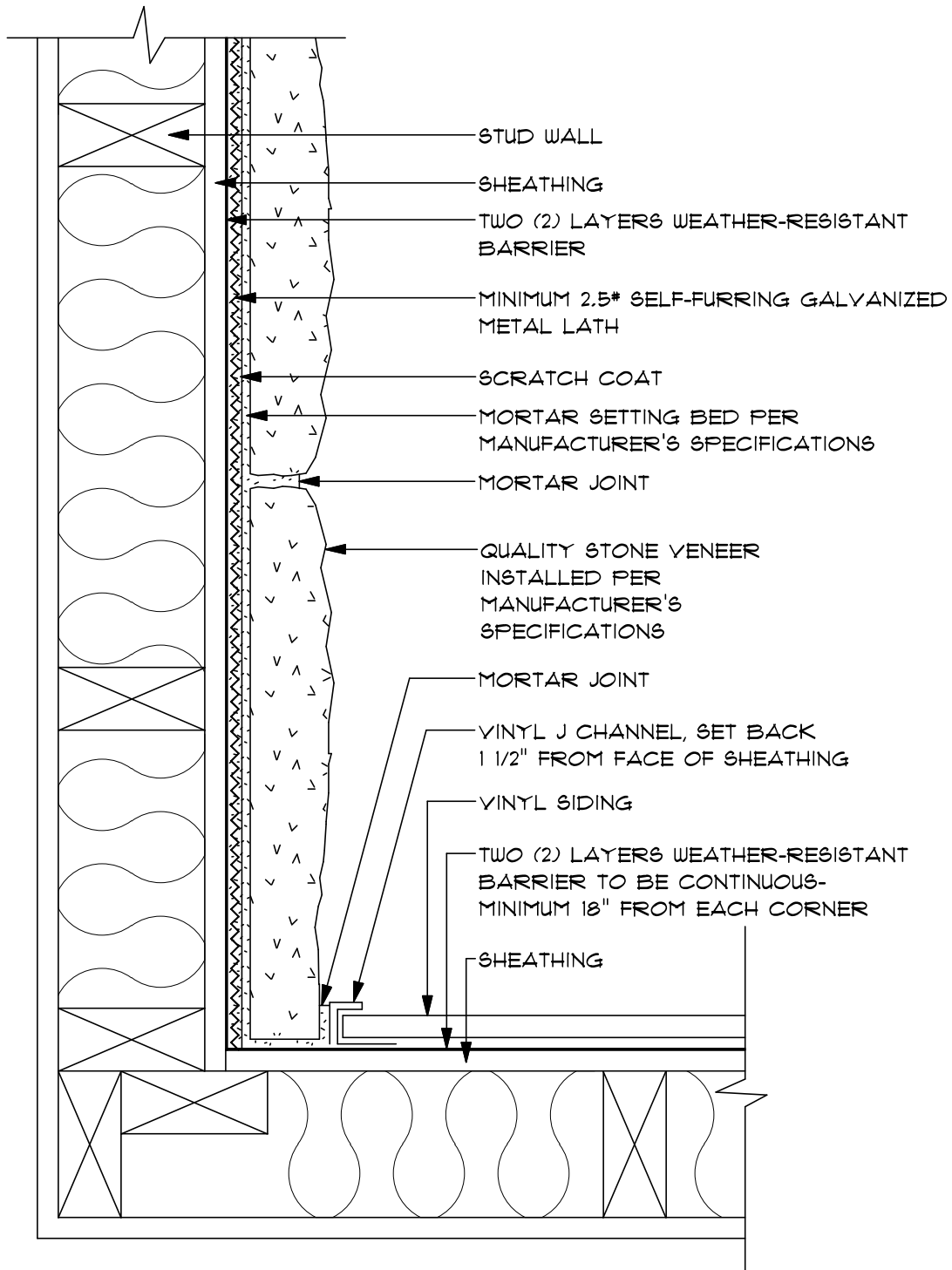

PLAN VIEW

QSY-10.0

SCALE: 3" = 1'-0"

INSIDE CORNER TRANSITION
AT MANUFACTURED STONE

FOR VINYL SIDING TRANSITION

QUALITY STONE VENEER

PHONE: 1-800-795-3229

FAX: 717-806-0961

WWW.QUALITYSTONEVENEER.COM



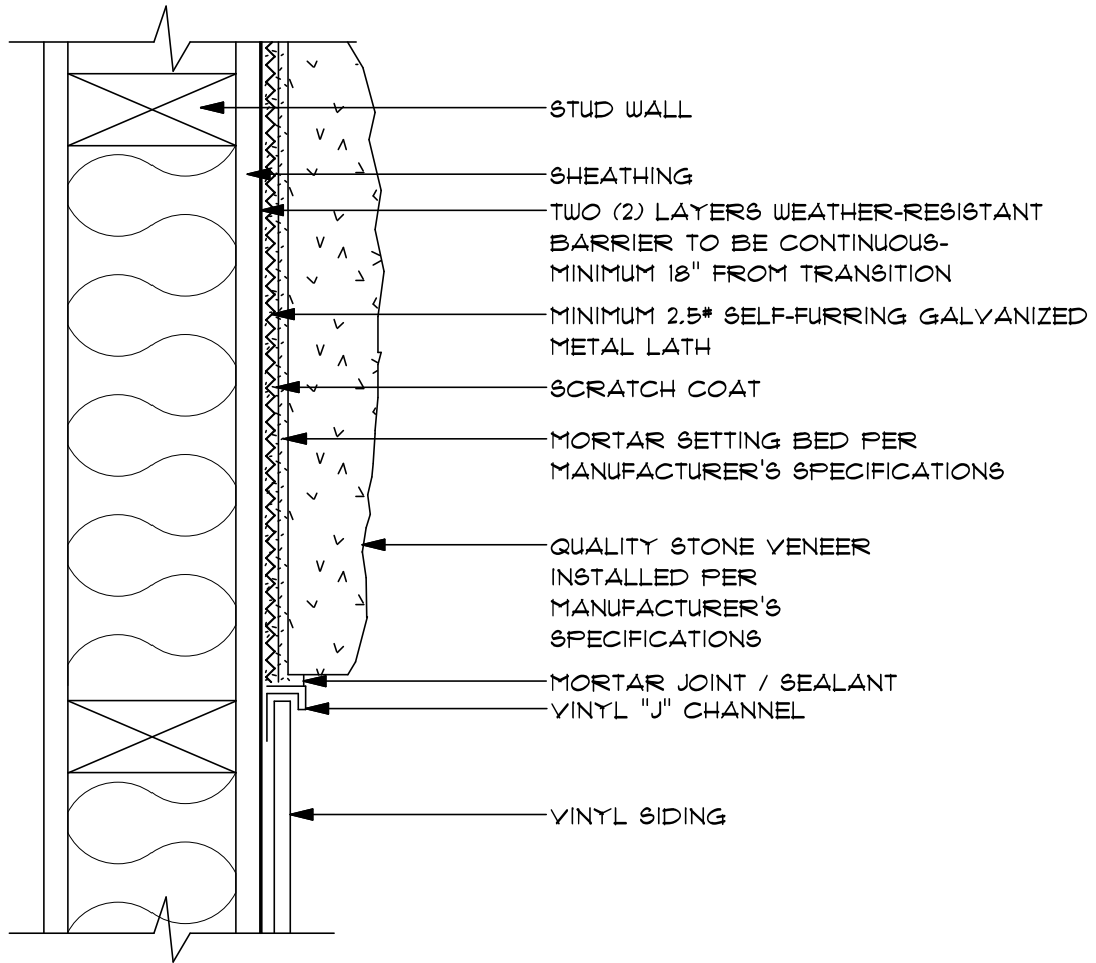

PLAN VIEW

QSY-11.0

SCALE: 3" = 1'-0"

FLAT SURFACE TRANSITION AT MANUFACTURED STONE

FOR BRICK, STUCCO, MASONITE,
WOOD & VINYL SIDING TRANSITION

QUALITY STONE VENEER

PHONE: 1-800-795-3229
FAX: 717-806-0961
WWW.QUALITYSTONEVENEER.COM



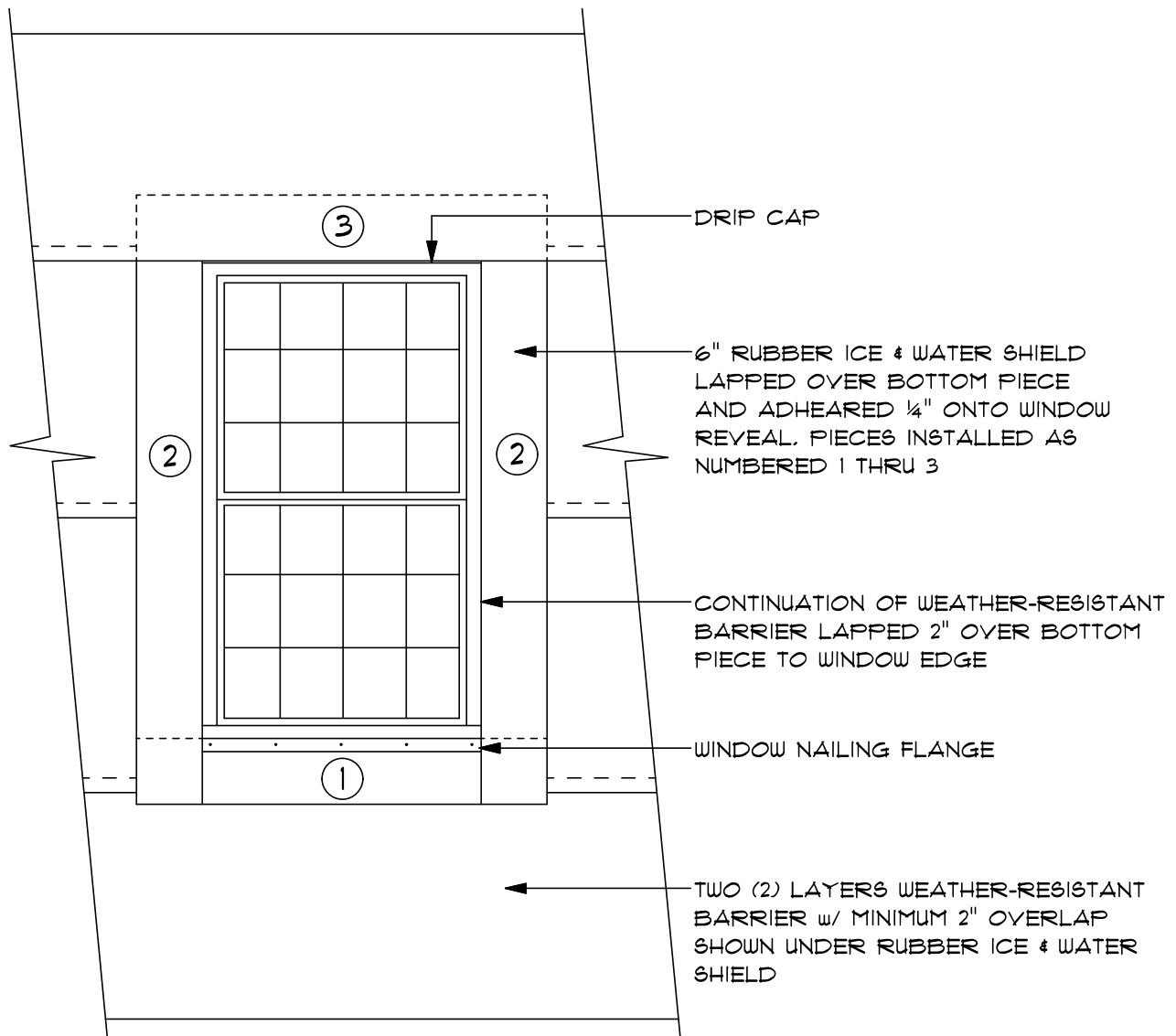

ELEVATION VIEW

QSV-12.0

NO SCALE

RUBBER ICE & WATER
SHIELD INSTALLATION
INSTRUCTIONS

QUALITY STONE VENEER

PHONE: 1-800-795-3229
FAX: 717-806-0961
WWW.QUALITYSTONEVENEER.COM



9/01

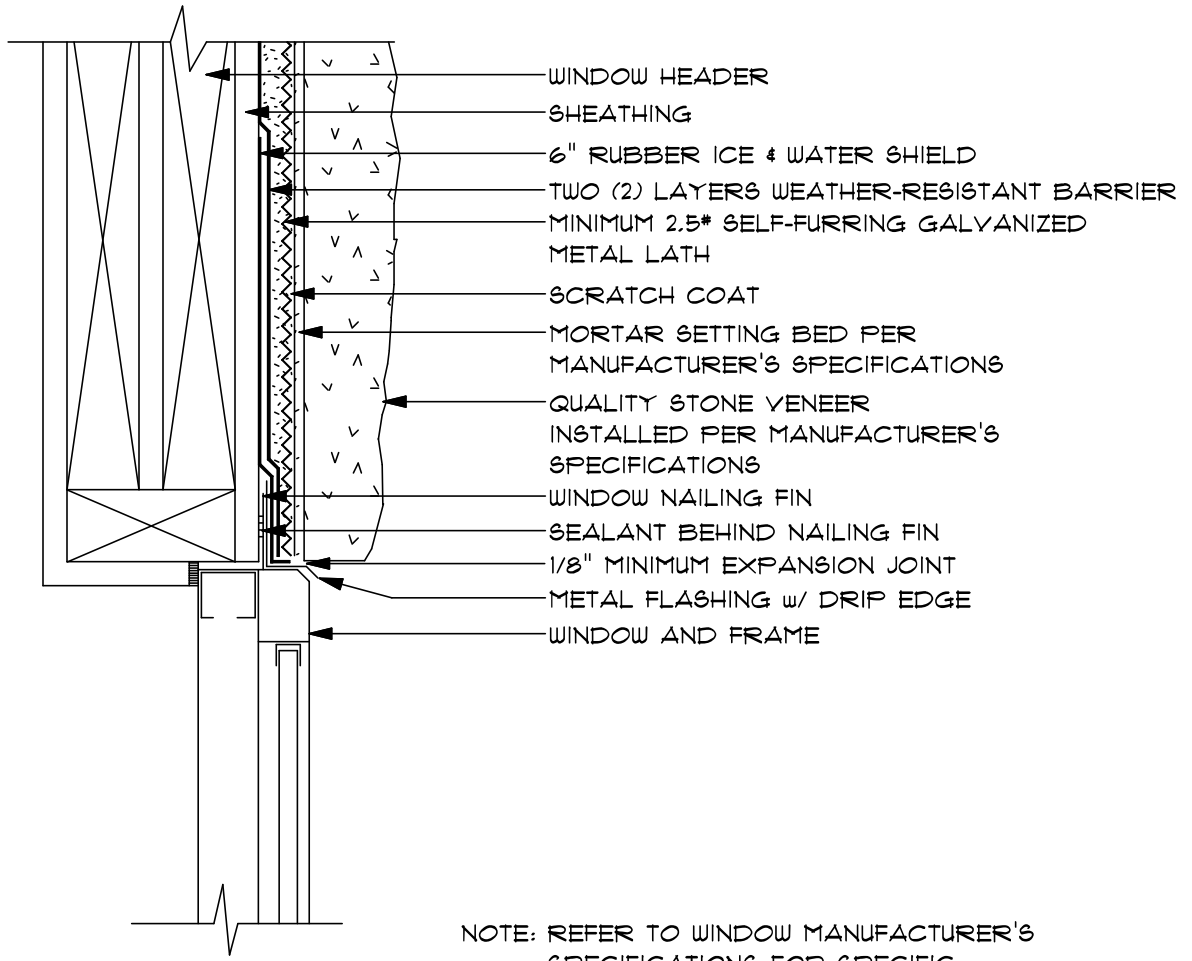

NOTE: REFER TO WINDOW MANUFACTURER'S SPECIFICATIONS FOR SPECIFIC INSTALLATION REQUIREMENTS.

SECTION VIEW

9/01

QSV-13.0
SCALE: 3" = 1'-0"

TOP OF WINDOW DETAIL
AT MANUFACTURED STONE
INSTALLATION AT STUD WALL

QUALITY STONE VENEER

PHONE: 1-800-795-3229
FAX: 717-806-0961
WWW.QUALITYSTONEVENEER.COM

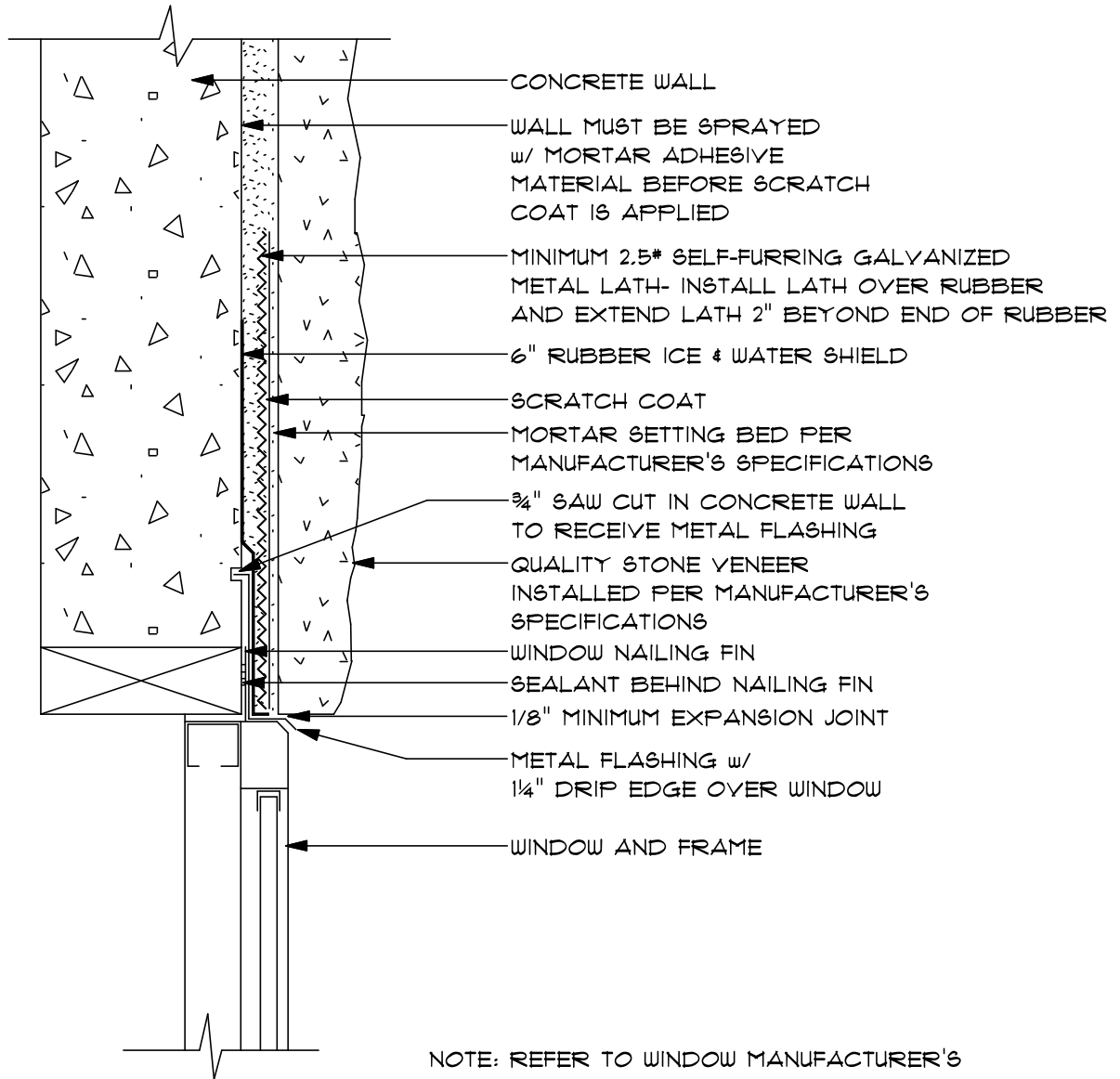

SECTION VIEW

9/01

QSV-14.0

SCALE: 3" = 1'-0"

TOP OF WINDOW DETAIL
AT MANUFACTURED STONE

INSTALLATION AT CONCRETE WALL

QUALITY STONE VENEER

PHONE: 1-800-795-3229
FAX: 717-806-0961

WWW.QUALITYSTONEVENEER.COM



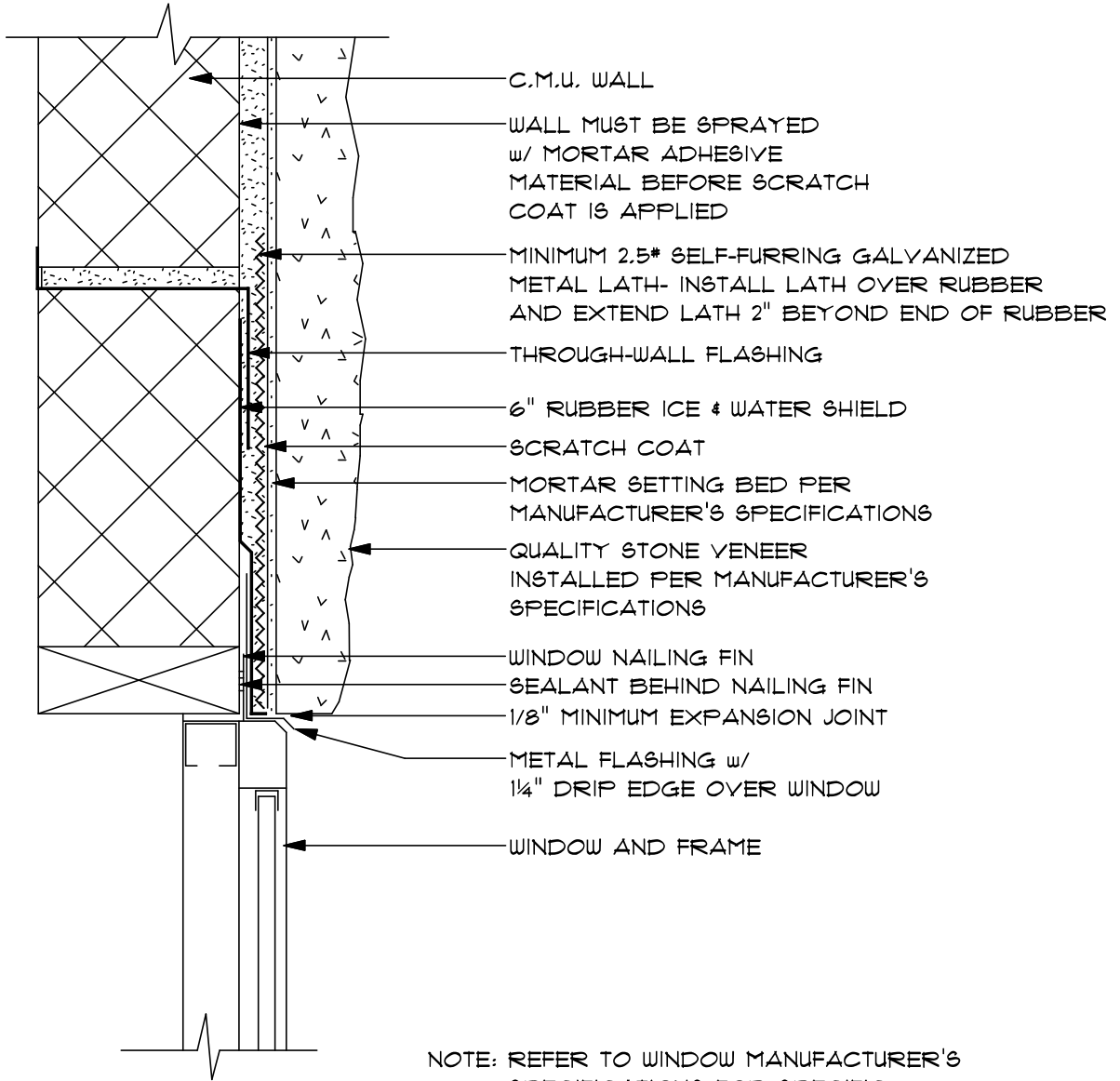

- C.M.U. WALL
- WALL MUST BE SPRAYED w/ MORTAR ADHESIVE MATERIAL BEFORE SCRATCH COAT IS APPLIED
- MINIMUM 2.5* SELF-FURRING GALVANIZED METAL LATH- INSTALL LATH OVER RUBBER AND EXTEND LATH 2" BEYOND END OF RUBBER
- THROUGH-WALL FLASHING
- 6" RUBBER ICE & WATER SHIELD
- SCRATCH COAT
- MORTAR SETTING BED PER MANUFACTURER'S SPECIFICATIONS
- QUALITY STONE VENEER INSTALLED PER MANUFACTURER'S SPECIFICATIONS
- WINDOW NAILING FIN
- SEALANT BEHIND NAILING FIN
- 1/8" MINIMUM EXPANSION JOINT
- METAL FLASHING w/ 1/4" DRIP EDGE OVER WINDOW
- WINDOW AND FRAME

NOTE: REFER TO WINDOW MANUFACTURER'S SPECIFICATIONS FOR SPECIFIC INSTALLATION REQUIREMENTS.

SECTION VIEW

9/01

QSV-15.0
SCALE: 3" = 1'-0"

TOP OF WINDOW DETAIL
AT MANUFACTURED STONE
INSTALLATION AT C.M.U. WALL

QUALITY STONE VENEER

PHONE: 1-800-795-3229
FAX: 717-806-0961
WWW.QUALITYSTONEVENEER.COM

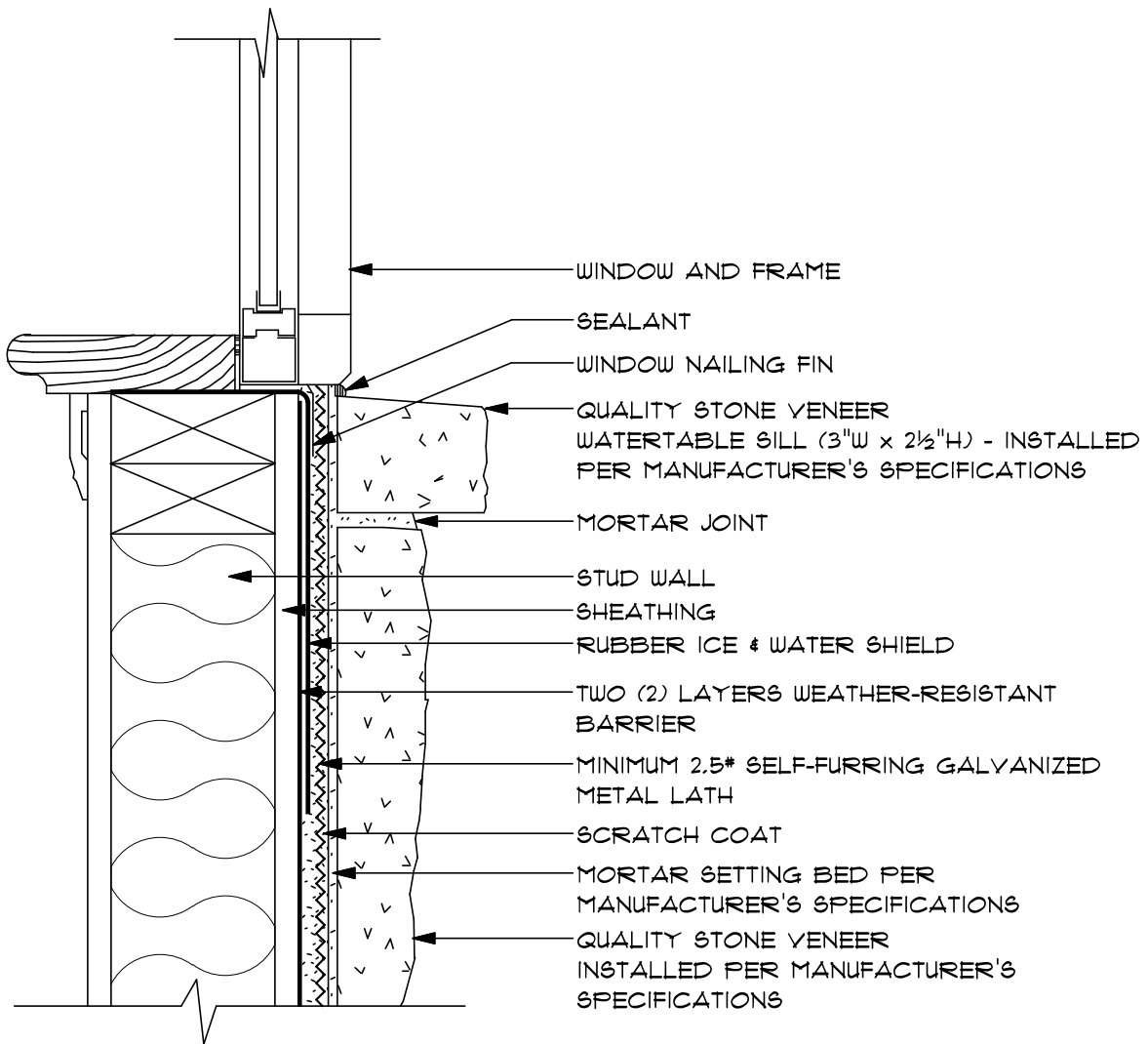

NOTE: REFER TO WINDOW MANUFACTURER'S SPECIFICATIONS FOR SPECIFIC INSTALLATION REQUIREMENTS.

SECTION VIEW

9/07

QSY-16.0

SCALE: 3" = 1'-0"

BOTTOM OF WINDOW DETAIL
AT MANUFACTURED STONE

QUALITY STONE VENEER

PHONE: 1-800-795-3229
FAX: 717-206-0961
WWW.QUALITYSTONEVENEER.COM



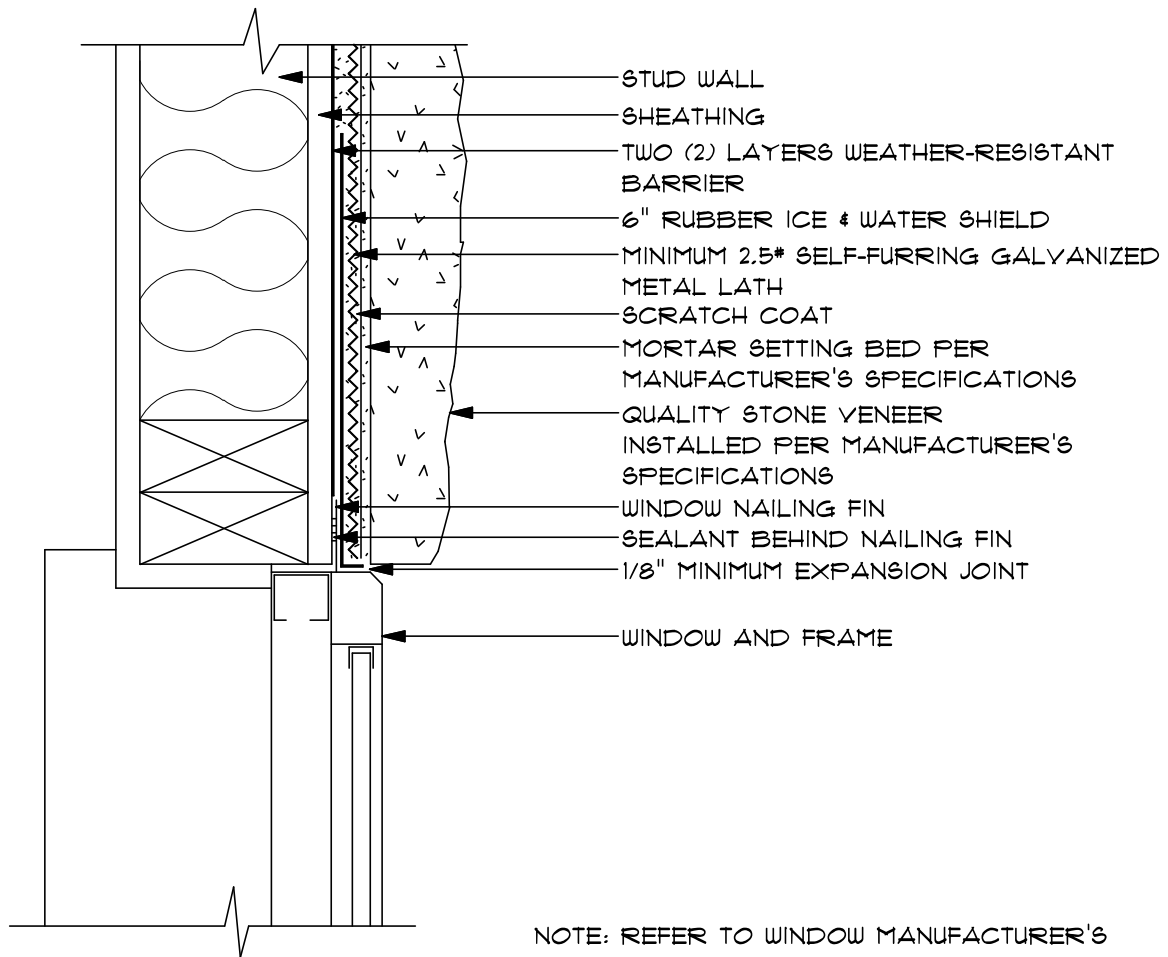

NOTE: REFER TO WINDOW MANUFACTURER'S SPECIFICATIONS FOR SPECIFIC INSTALLATION REQUIREMENTS.

PLAN VIEW

9/07

QSV-17.0

SCALE: 3" = 1'-0"

SIDE OF WINDOW DETAIL
AT MANUFACTURED STONE

QUALITY STONE VENEER

PHONE: 1-800-795-3229
FAX: 717-806-0961
WWW.QUALITYSTONEVENEER.COM



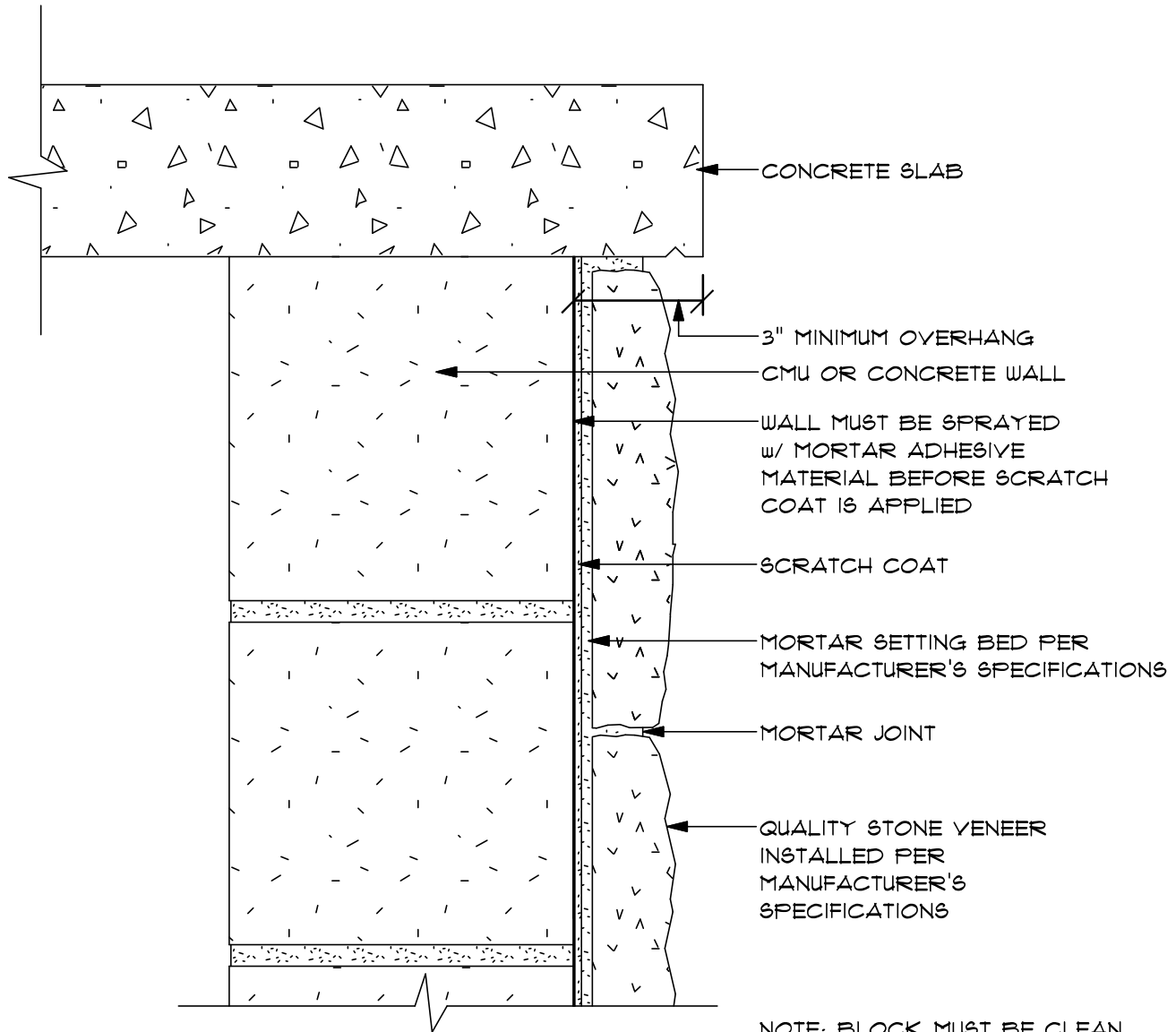

SECTION VIEW

QSV-18.0

SCALE: 3" = 1'-0"

MANUFACTURED STONE
ON C.M.U. WALL

AT PORCH FOUNDATION

QUALITY STONE VENEER

PHONE: 1-800-795-3229
FAX: 717-806-0961

WWW.QUALITYSTONEVENEER.COM



1/07

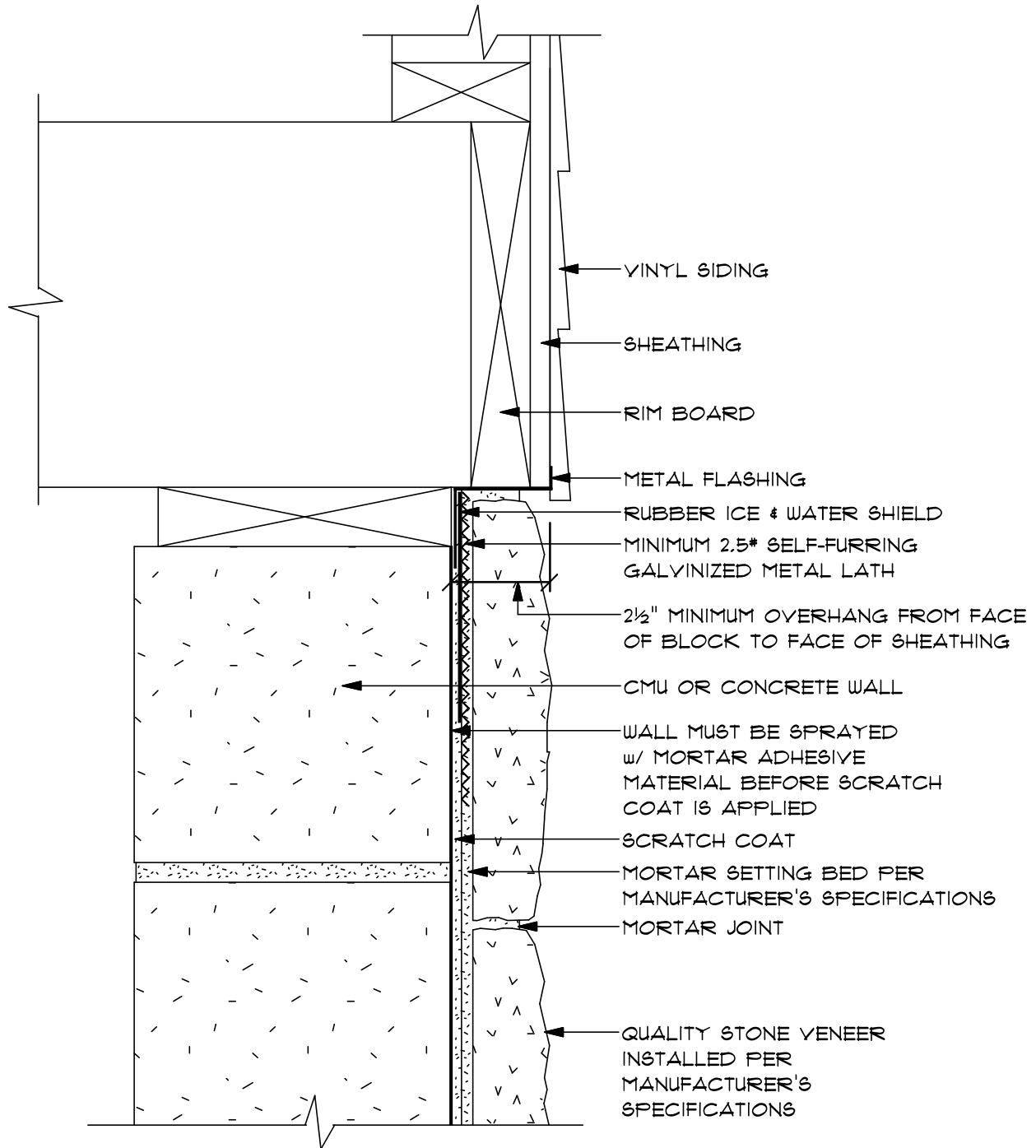

- ← VINYL SIDING
- ← SHEATHING
- ← RIM BOARD
- ← METAL FLASHING
- ← RUBBER ICE & WATER SHIELD
- ← MINIMUM 2.5# SELF-FURRING GALVANIZED METAL LATH
- ← 2½" MINIMUM OVERHANG FROM FACE OF BLOCK TO FACE OF SHEATHING
- ← CMU OR CONCRETE WALL
- ← WALL MUST BE SPRAYED w/ MORTAR ADHESIVE MATERIAL BEFORE SCRATCH COAT IS APPLIED
- ← SCRATCH COAT
- ← MORTAR SETTING BED PER MANUFACTURER'S SPECIFICATIONS
- ← MORTAR JOINT
- ← QUALITY STONE VENEER INSTALLED PER MANUFACTURER'S SPECIFICATIONS

NOTE: BLOCK MUST BE CLEAN AND FREE FROM DIRT AND OTHER FOREIGN MATERIAL BEFORE INSTALLATION OF STONE

SECTION VIEW

9/01

QSV-19.0
SCALE: 3" = 1'-0"

MANUFACTURED STONE ON FOUNDATION WALL
CMU OR CONCRETE

QUALITY STONE VENEER
PHONE: 1-800-795-3229
FAX: 717-806-0961
WWW.QUALITYSTONEVENEER.COM

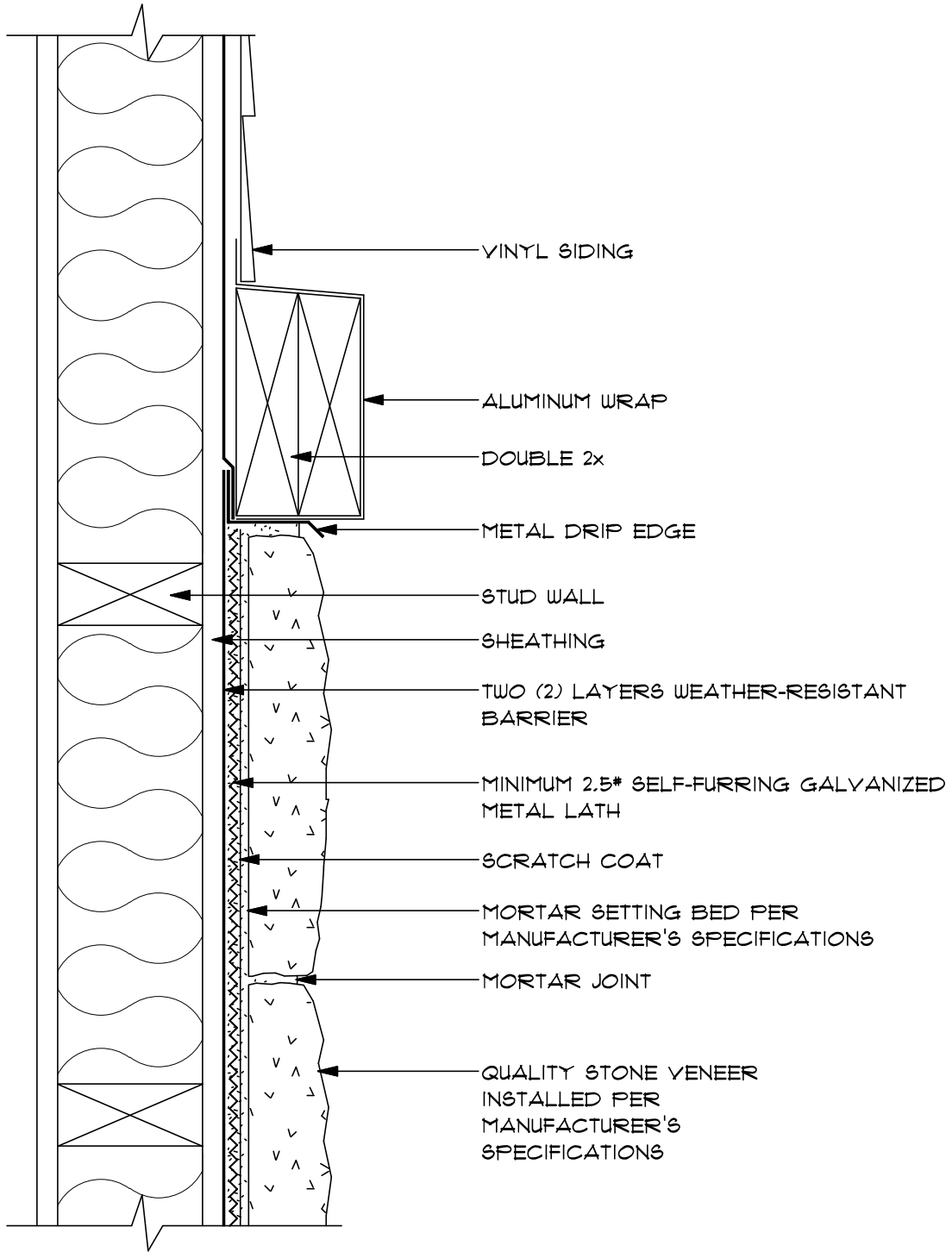

SECTION VIEW

9/07

QSV-20.0

SCALE: 3" = 1'-0"

MANUFACTURED STONE
BELOW TRIM ACCENT BAND

QUALITY STONE VENEER

PHONE: 1-800-795-3229
FAX: 717-806-0961
WWW.QUALITYSTONEVENEER.COM



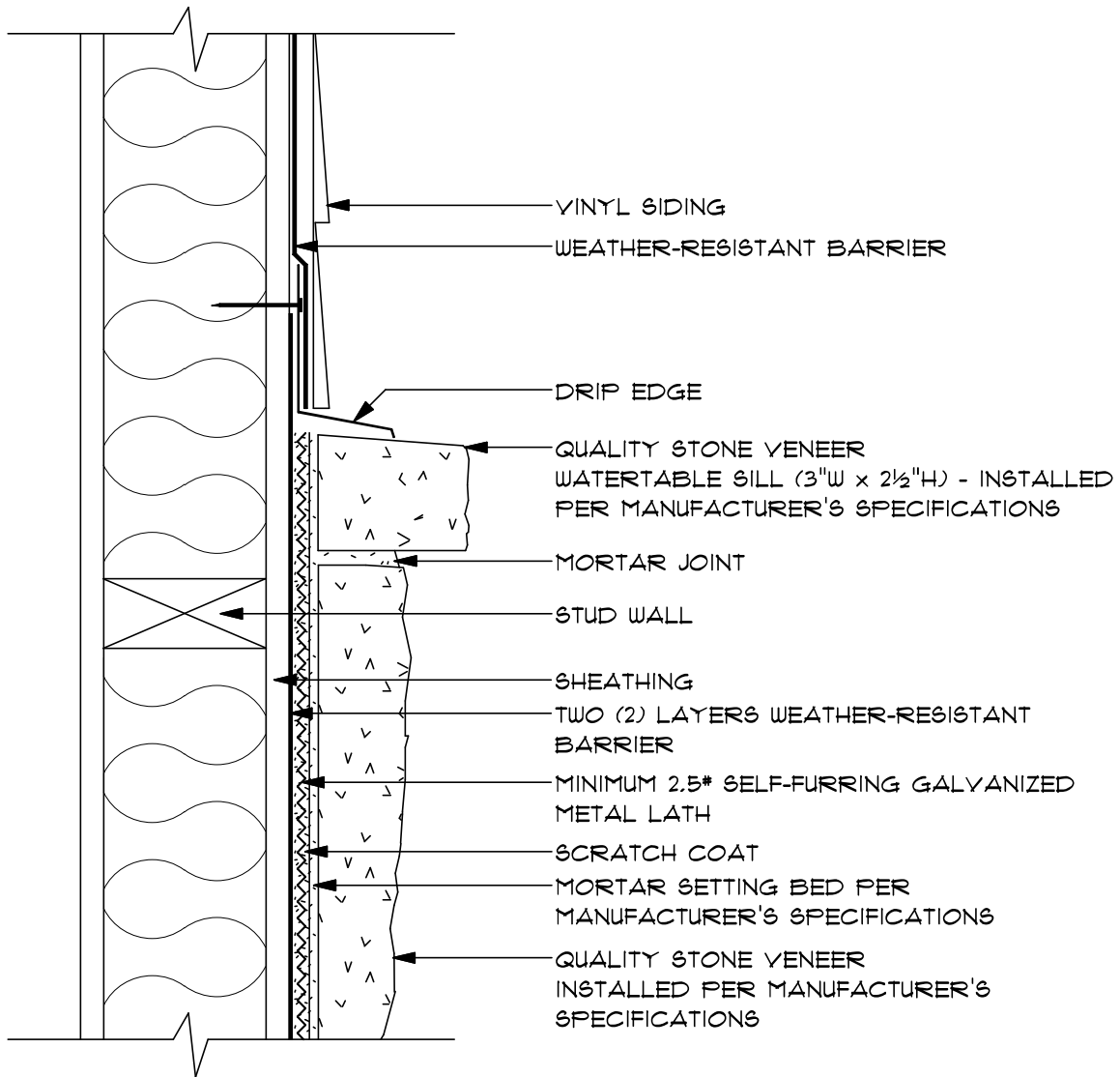

SECTION VIEW

QSY-21.0

SCALE: 3" = 1'-0"

MANUFACTURED STONE

AT KNEE WALL
FOR STUCCO, MASONITE,
WOOD & VINYL SIDING

QUALITY STONE VENEER

PHONE: 1-800-795-3229
FAX: 717-806-0961
WWW.QUALITYSTONEVENEER.COM



9/07

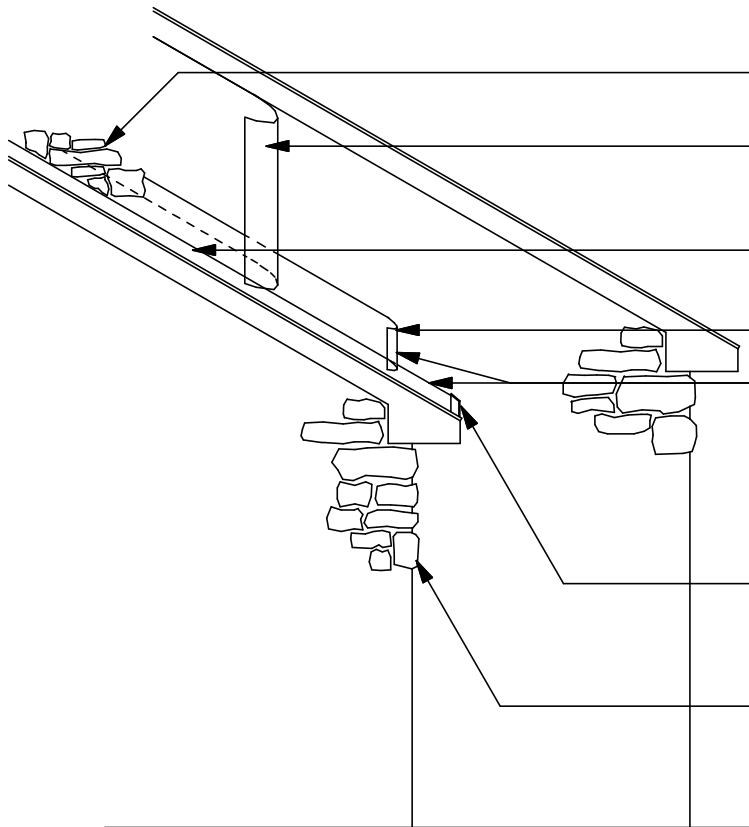

QUALITY STONE VENEER INSTALLED PER MANUFACTURER'S SPECIFICATIONS

TWO (2) LAYERS WEATHER-RESISTANT BARRIER PER MANUFACTURER'S SPECIFICATIONS

2x4 CAPPED w/ METAL COUNTER FLASHING OVER STEP FLASHING

6" RUBBER ICE & WATER SHIELD

ROOF STEP FLASHING AND RUBBER ICE & WATER SHIELD MUST TURN OUT IN MORTAR JOINT AT ROOF EDGE TO KEEP WATER FROM RUNNING BEHIND VENEERS BELOW ROOF EDGE

METAL KICKOUT INSTALLED PER MANUFACTURER'S SPECIFICATIONS TO DEFLECT WATER AWAY FROM STONE

QUALITY STONE VENEER INSTALLED PER MANUFACTURER'S SPECIFICATIONS

ELEVATION VIEW

9/01

QSV-22.0

NO SCALE

STONE OVER ROOF DETAIL

QUALITY STONE VENEER

PHONE: 1-800-795-3229
 FAX: 717-806-0961
 WWW.QUALITYSTONEVENEER.COM



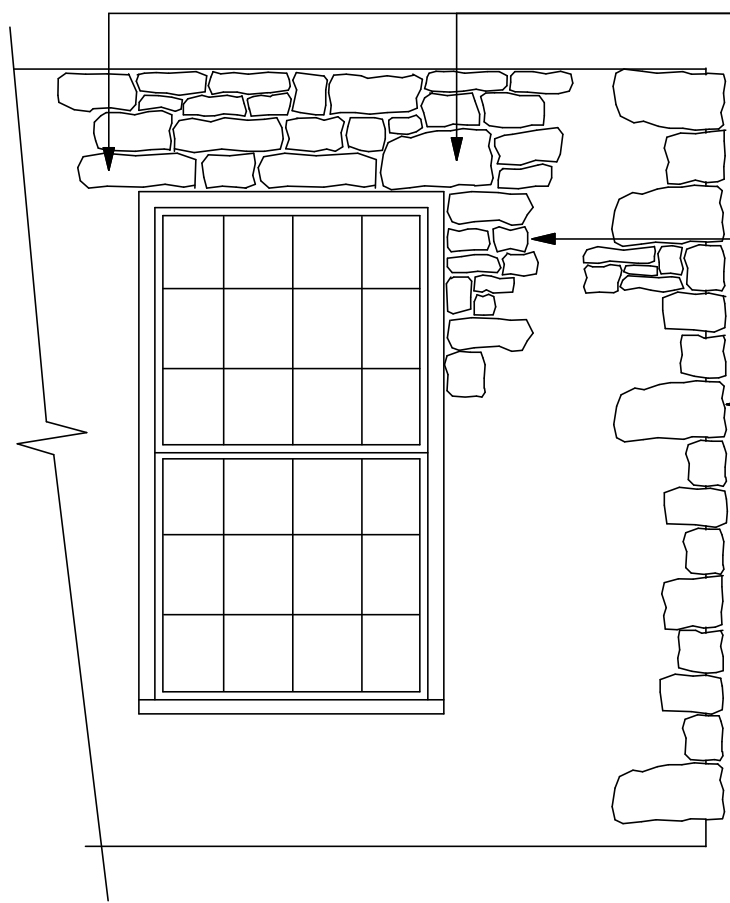

WINDOW HEADS SHOULD HAVE STONE EXTENDING MINIMUM 4" OUT OVER TOP OF WINDOW TO GIVE APPEARANCE OF NATURAL LINTEL

SIDE OF WINDOWS AND DOORS SHOULD BE KEYPED TOGETHER

CORNERS MAY NEED TO BE CUT w/ SAW SO THAT THEY ARE KEYPED TOGETHER WITH FLATS

ELEVATION VIEW

QSV-23.0

NO SCALE

QUALITY STONE VENEER
CORNER STONE
INSTALLATION INSTRUCTIONS

QUALITY STONE VENEER

PHONE: 1-800-795-3229
 FAX: 717-806-0961
 WWW.QUALITYSTONEVENEER.COM



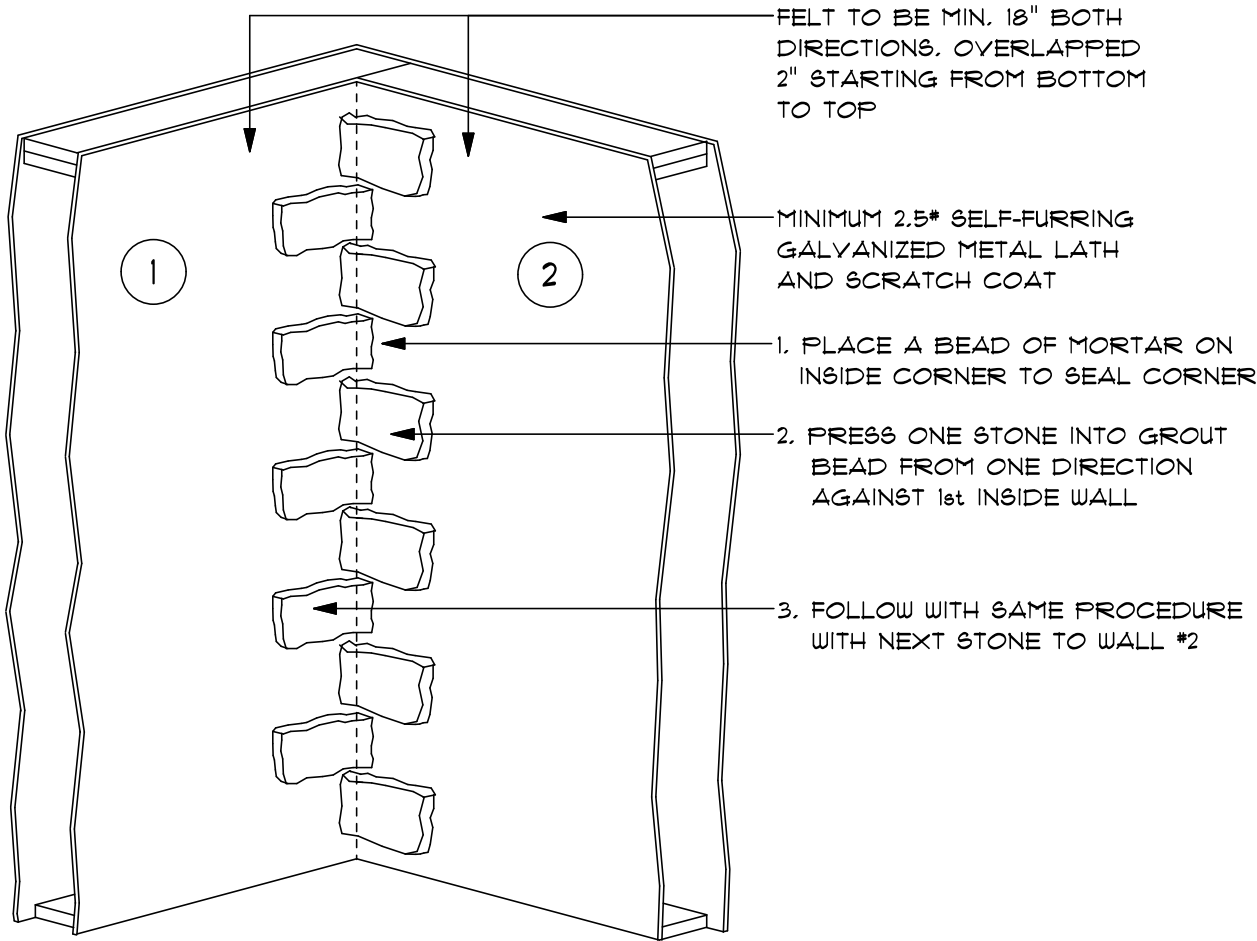

ELEVATION VIEW

9/01

QSY-24.0

NO SCALE

INSIDE CORNER
INSTALLATION INSTRUCTIONS

QUALITY STONE VENEER

PHONE: 1-800-795-3229
 FAX: 717-806-0961
 WWW.QUALITYSTONEVENEER.COM



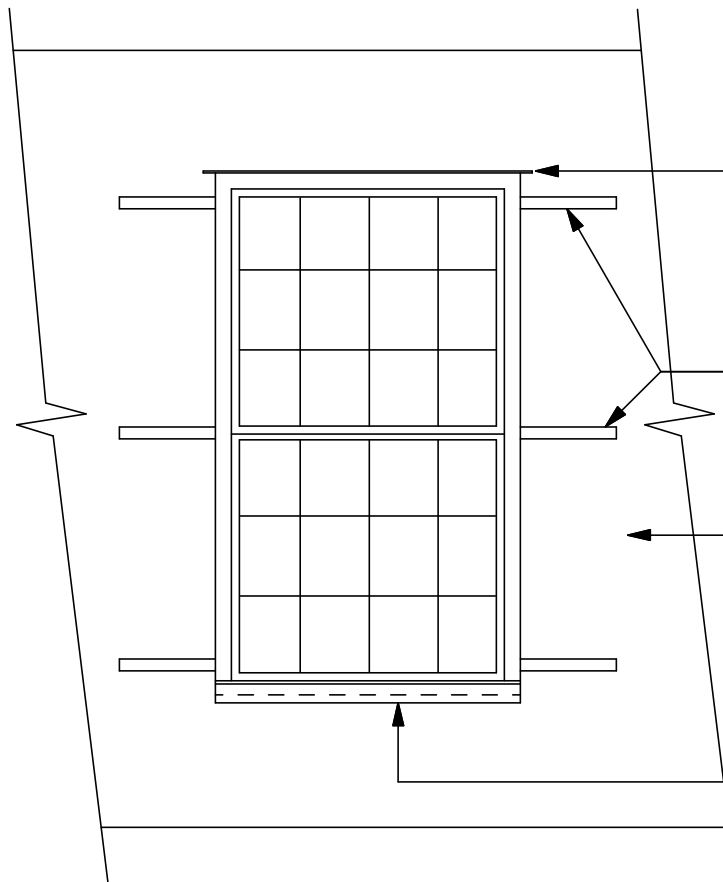

DRIP CAP AND 6" RUBBER ICE & WATER SHIELD TO ALL WINDOW HEADS w/ DRIP EDGE EXTENDING A MINIMUM OF 1 1/2" PAST SIDES OF WINDOW

INSTALL Q.S.V. SHUTTER BLOCK 3" FROM TOP & BOTTOM AND AT THE WINDOW MIDPOINT ON BOTH SIDES OF WINDOW

FOLLOW INSTALLATION INSTRUCTIONS FOR MANUFACTURER'S SPECIFICATIONS FOR RUBBER ICE & WATER SHIELD, TWO (2) LAYERS WEATHER-RESISTANT BARRIER, MINIMUM 2.5# SELF-FURRING GALVANIZED METAL LATH & MORTAR SETTING BED

WINDOW SILL w/ SLOPE AWAY FROM WINDOW, CUT MORTAR JOINT OUT SO THAT SILL MAY BE CAULKED LATER BY CONTRACTOR

ELEVATION VIEW

9/01

QSY-25.0

SCALE: 3" = 1'-0"

SHUTTER BLOCK
INSTALLATION INSTRUCTIONS

QUALITY STONE VENEER

PHONE: 1-800-795-3229
FAX: 717-806-0961
WWW.QUALITYSTONEVENEER.COM





MANTLE (6"/9" x 72"/18")



11 1/2"



48" METAL CLIP

TOP PANEL

5 1/2"

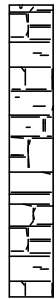

3'-0 1/2"

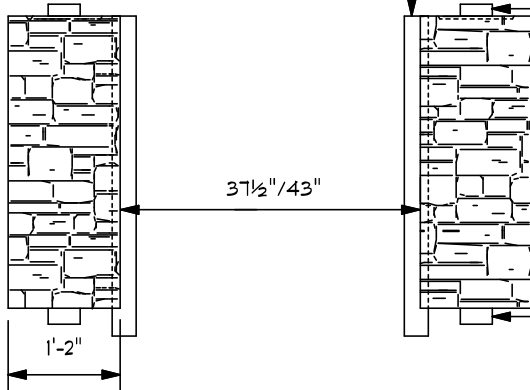

4" FIREBOX METAL EXTENSION

8" METAL CLIP

NOTE: ADHESIVE MUST BE USED ON THE BACK AND BETWEEN ALL PANELS

SIDE PANEL

8" METAL CLIP

37 1/2"/43"

1'-2"

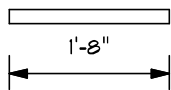

1'-8"

1 3/4"

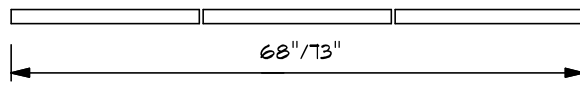

68"/73"

HEARTH STONES- ADHESIVE MUST BE USED TO ATTACH HEARTH STONES TO RAISED HEARTH PLATFORM OR SUBFLOOR

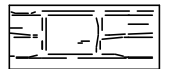

8"

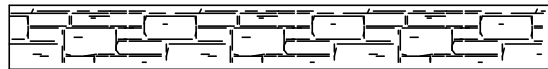

RAISED HEARTH (OPTIONAL)

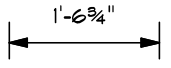

1'-6 3/4"

FRONT VIEW

SIDE VIEW

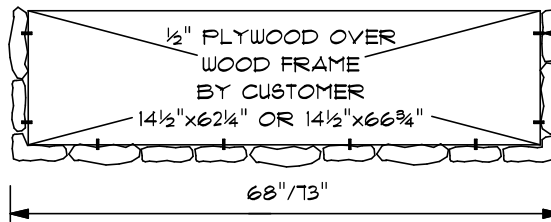

1/2" PLYWOOD OVER WOOD FRAME BY CUSTOMER

14 1/2" x 62 1/4" OR 14 1/2" x 66 3/4"

METAL BRICK TIES

STONE FACING

68"/73"

RAISED HEARTH PLAN

1/07

QSY-26.0

SCALE: 1/2" = 1'-0"

QUALITY STONE VENEER
FIREPLACE

WITH HEARTH AND MANTLE

QUALITY STONE VENEER

PHONE: 1-800-795-3229
FAX: 717-806-0961

WWW.QUALITYSTONEVENEER.COM



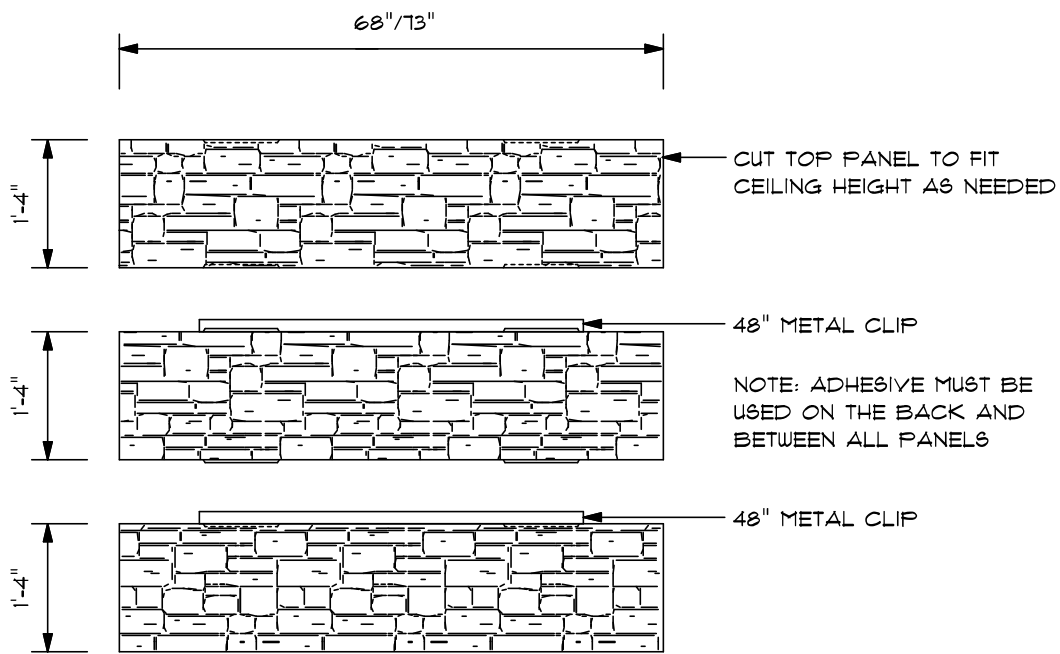

DRYSTACK UPPER PANEL

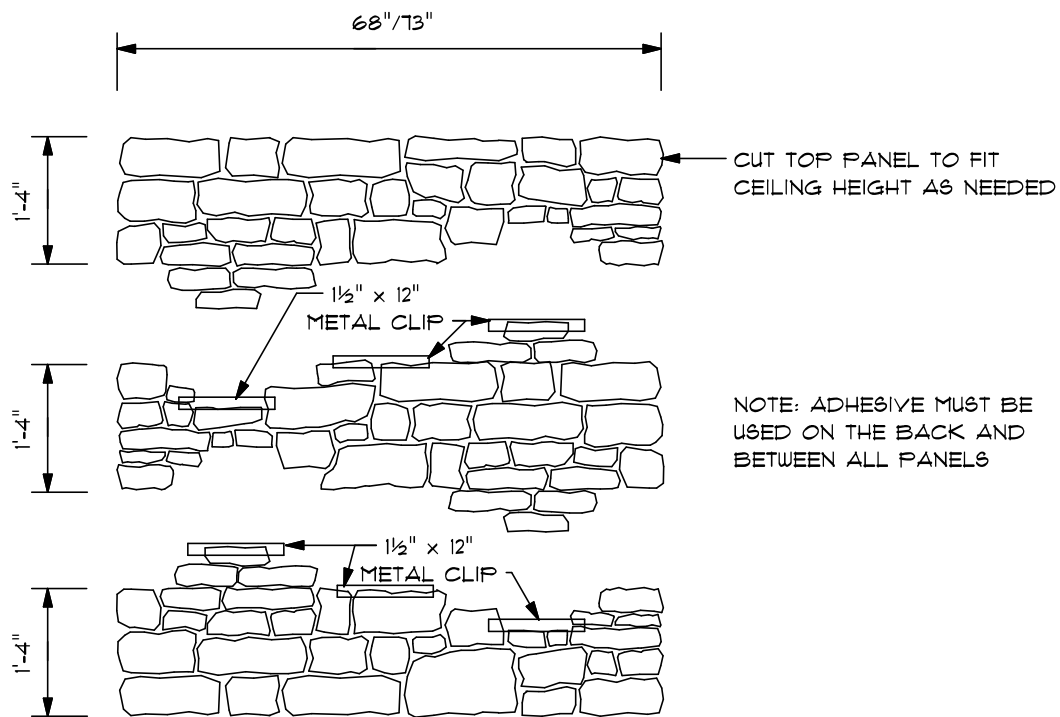

FIELDSTONE UPPER PANEL

QSV-27.0

SCALE: 1/2" = 1'-0"

QUALITY STONE VENEER
FIREPLACE

UPPER PANEL OPTIONS

QUALITY STONE VENEER

PHONE: 1-800-795-3229
FAX: 717-806-0961

WWW.QUALITYSTONEVENEER.COM



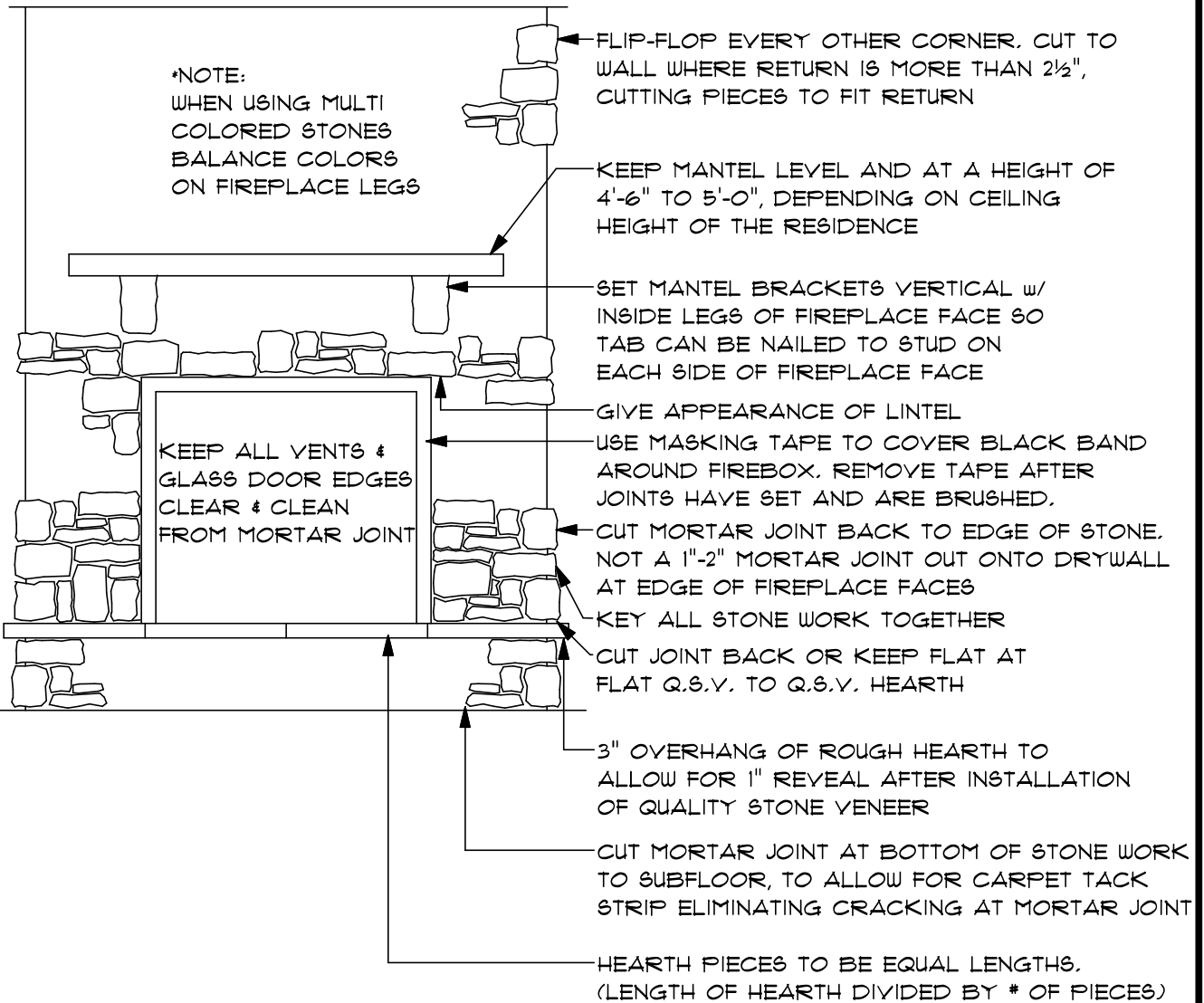

ELEVATION VIEW

QSV-28.0

NO SCALE

QUALITY STONE VENEER
FIREPLACE DETAILS

QUALITY STONE VENEER

PHONE: 1-800-795-3229
FAX: 717-806-0961
WWW.QUALITYSTONEVENEER.COM



1/01

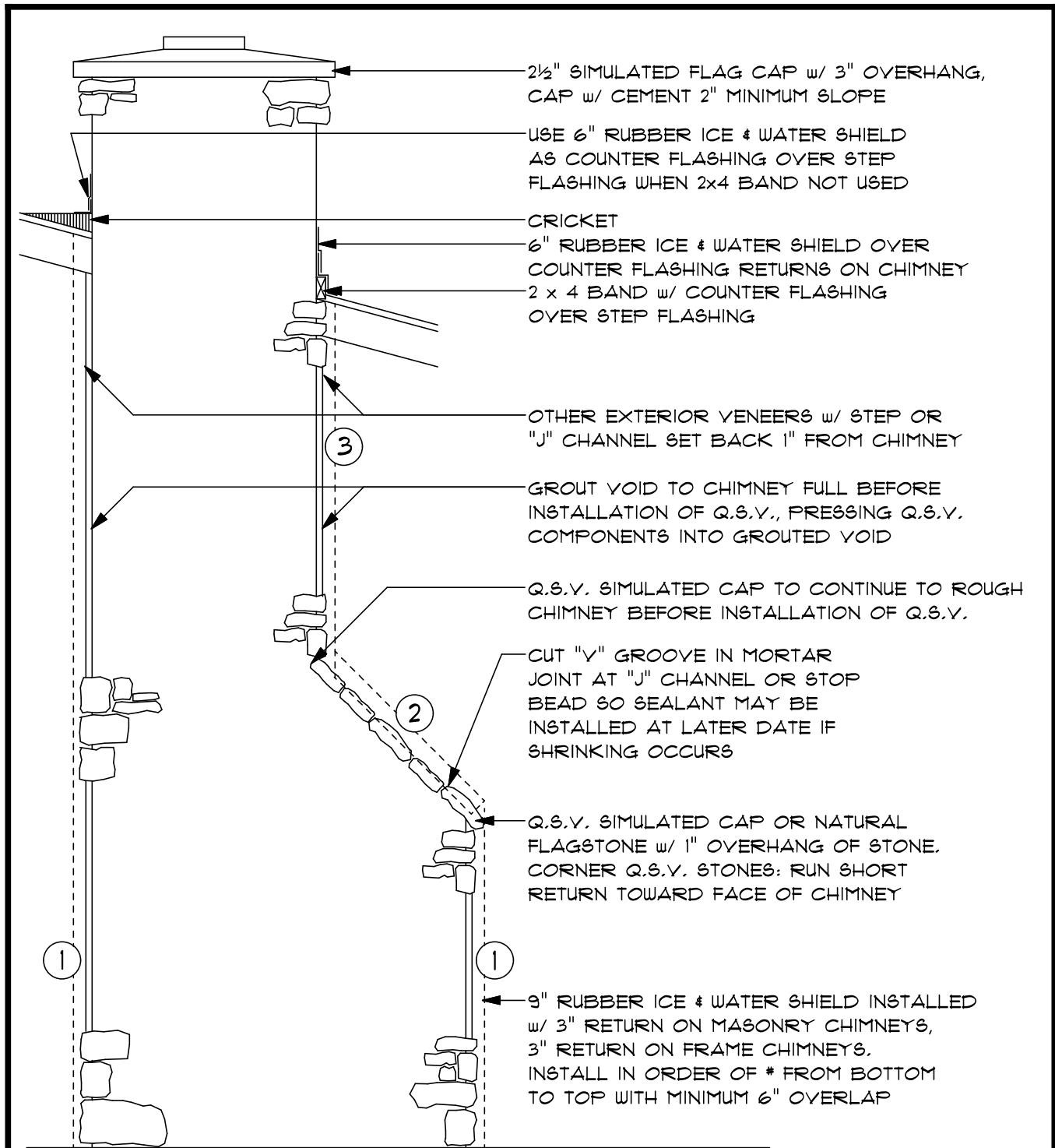

ELEVATION VIEW

QSV-29.0

NO SCALE

CHIMNEY TO GRADE
w/ RAKES DETAIL

QUALITY STONE VENEER

PHONE: 1-800-795-3229
FAX: 717-806-0961
WWW.QUALITYSTONEVENEER.COM



1/01

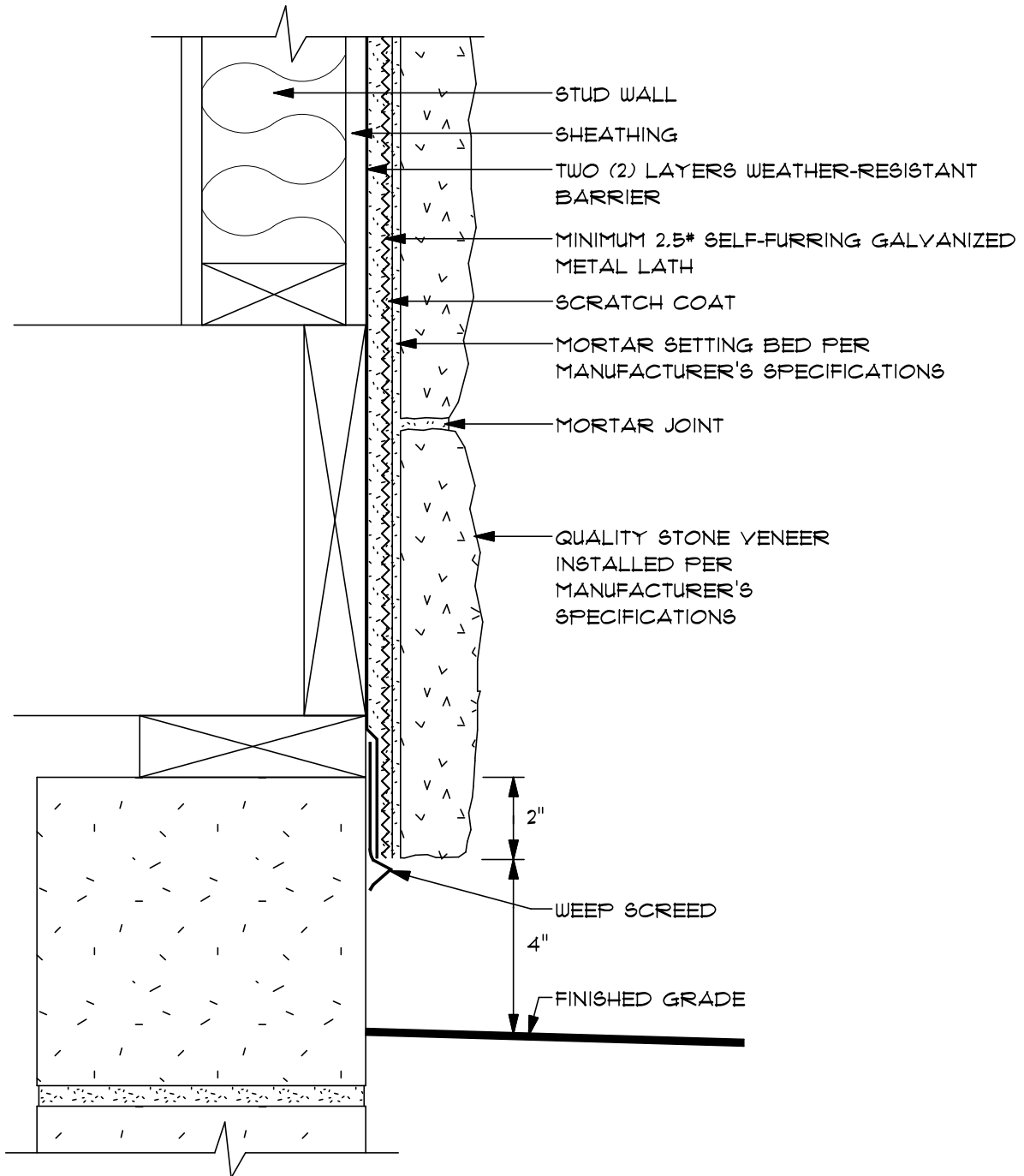

SECTION VIEW

QSV-30.0

SCALE: 3" = 1'-0"

MANUFACTURED STONE
ON STUD WALL

WEEP SCREED INSTALLED AT C.M.U.

QUALITY STONE VENEER

PHONE: 1-800-795-3229

FAX: 717-806-0961

WWW.QUALITYSTONEVENEER.COM

